

PROJECT MANUAL

Open Channel Cleanout

Drainage District No. 57

Cerro Gordo County, Iowa

1609 US Hwy 18 East • Algona, IA 50511
Ph: (515) 395-3140



Bolton-Menk.com

SECTION 00005 – CERTIFICATION

PROJECT MANUAL

for

Open Channel Cleanout

Drainage District No. 57

Cerro Gordo County, Iowa

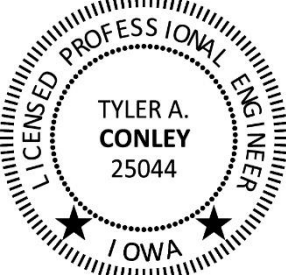
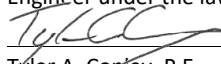
 <p>TYLER A. CONLEY 25044</p> <p>LICENSED PROFESSIONAL ENGINEER IOWA</p>	<p>I hereby certify that this engineering document was prepared by me or under my direct personal supervision and that I am a duly licensed Professional Engineer under the laws of the State of Iowa.</p> <p> Tyler A. Conley, P.E. License No. 25044 My renewal date is December 31, 2025 Pages or sheets covered by this seal: <u>Entire Document</u></p> <p>Date: <u>5/6/2024</u></p>
---	--

SECTION 00010 - TABLE OF CONTENTS

Open Channel Cleanout
Drainage District No. 57
Cerro Gordo County, Iowa

CONTRACT DOCUMENTS:

PROJECT MANUAL:

Introductory Information, Bidding Requirements, Contract Forms and Conditions of Contract

00005 - CERTIFICATION PAGE

00010 - TABLE OF CONTENTS

00100 - NOTICE TO BIDDERS

00200 - INSTRUCTIONS TO BIDDERS

00410 - PROPOSAL

00410 - PROPOSAL ATTACHMENT: BID ITEMS

00420 - BID BOND

00500 - CONTRACT

00610 - PERFORMANCE, PAYMENT AND MAINTENANCE BOND

00800 - SPECIAL PROVISIONS, PART 1 - GENERAL REQUIREMENTS

00800 - SPECIAL PROVISIONS, PART 2 - DRAINAGE DISTRICT IMPROVEMENTS/REPAIRS

Technical Specifications

Supplemental Specifications

Rural Public Drainage Repairs & Improvements

DRAWINGS (UNDER SEPARATE COVER):

Thirteen (13) sheets numbered A.01 through X.05 inclusive, dated May 6, 2024, and with each sheet bearing the following general title:

Open Channel Cleanout
Drainage District No. 57
Cerro Gordo County, Iowa

APPENDICES

None

**This project is based on
SUDAS STANDARD SPECIFICATIONS, 2024 EDITION
unless modified herein.**

******END OF SECTION******

SECTION 00100 - NOTICE TO BIDDERS

Open Channel Cleanout
Drainage District No. 57
Cerro Gordo County, Iowa

Time and Place for Filing Sealed Proposals. Sealed bids for the work comprising the repair as stated below must be filed before 10:00 a.m. on May 30, 2024, in the office of the County Auditor, 220 N. Washington Ave., Mason City, Iowa.

Time and Place Sealed Proposals Will be Opened and Considered. Sealed proposals will be opened, and bids tabulated at 10:00 a.m. on May 30, 2024, in the Board Room of the Cerro Gordo County Board of Supervisors, for consideration by Drainage District Trustees at its meeting at 10:10 a.m. on June 3, 2024. The Drainage District Trustees reserves the right to reject any and all bids.

Time for Commencement and Completion of Work. Work on the Repair shall commence upon approval of the contract by the Trustees, and as stated in the Notice to Proceed. All work under the Contract must be substantially complete on or before September 30, 2024. Damages in the amount of \$500.00 per day will be assessed for each day the work remains incomplete.

Bid Security. Each bidder shall accompany its bid with bid security, as defined in Section 468.35 of the Iowa Code in the amount equal to five percent of the total amount of the bid.

Contract Documents. Copies of the project documents are available for a price of \$25 per set. This fee is refundable, provided the plans and specifications are returned complete and in good usable condition, and they are returned within fourteen (14) calendar days after the award of the project. Please make your check payable to Bolton & Menk, Inc. and send it to 1609 US Hwy 18, Algona, Iowa 50511, (515) 395-3140. You may view the digital plan documents for free by entering Quest project #9105990 on the website's Project Search page. Documents may be downloaded for \$0.00. Please contact QuestCDN.com at 952-233-1632 or info@questcdn.com for assistance in free membership registration, viewing, downloading, and working with this digital project information.

Preference of Products and Labor. Preference shall be given to domestic construction materials by the contractor, subcontractors, material, men, and suppliers in performance of the contract and further, by virtue of statutory authority, preference will be given to products and provisions grown and coal produced within the State of Iowa, and to Iowa domestic labor, to the extent lawfully required under Iowa statutes. Failure to submit a fully completed Bidder Status Form with the bid may result in the bid being deemed nonresponsive and rejected.

Sales Tax Exemption Certificates. The bidder shall not include sales tax in the bid. The County Auditor will distribute tax exemption certificates and authorization letters to the Contractor and all subcontractors who are identified. The Contractor and subcontractor may make copies of the tax exemption certificates and provide a copy to each supplier providing construction materials. These tax exemption certificates and authorization letters are applicable only for this specific project under the Contract.

Payment for work done will be in accordance with estimates approved monthly by the Engineer and in Drainage Warrants issued by the Drainage District, which, if registered and stamped "not paid for want of funds", shall bear interest at a rate fixed by the Trustees not to exceed the maximum set by law in accordance with Chapter 468 of the Code of Iowa, as amended. The Trustees reserves the right to issue Drainage District Improvement Certificates pursuant to Chapter 468 of the Code of Iowa, as amended, which certificates may be given in exchange for outstanding warrants issued to the Contractor or to the holder thereof. Said warrants to be surrendered, if called by the Trustees, in exchange for Drainage District Improvement Certificates which shall be taken by the Contractor or holder at par and shall bear interest at a rate fixed by the Trustees not to exceed the maximum set by law in accordance with Chapter 468 of the Code of Iowa, as amended.

Progress payments will be made in an amount equal to ninety percent (90%) of the work completed. Final payment will be made not less than thirty (30) days after completion of the work and acceptance by the Board, subject to the conditions and in accordance with the provisions of Chapter 468 of the Code of Iowa, as amended.

PROJECT DESCRIPTION:

Construction of approximately 21.5 stations of open ditch excavation, 21.5 stations of spoil bank leveling, 21.5 stations of open ditch seeding and fertilizing, riprap placement, repairs to surface drainpipes and tile extension pipes, and all other miscellaneous items related thereto.

All bidders are required to complete "Proposal, attachment C, Bid Items and Quantities" to be considered for award.

The Board of Supervisors acting as Trustees will select any or no bid that is in the best interest of the Drainage District and the County Secondary Road Department.

This Notice is given by authority of the Drainage District Trustees in Cerro Gordo County, Iowa.

Adam Wedmore, Cerro Gordo County Auditor

SECTION 00200 - INSTRUCTIONS TO BIDDERS

Open Channel Cleanout
Drainage District No. 57
Cerro Gordo County, Iowa

The work comprising the above referenced project shall be constructed in accordance with the SUDAS Standard Specifications, 2024 Edition and as further modified by supplemental specifications and special provision included in the contract documents. The terms used in the contract version of the documents are defined in said Standard Specifications. Before submitting your bid, please review the requirements of Division One, General Provisions and Covenants. Please be certain that all documents have been completed properly, as failure to complete and sign all documents and to comply with the requirements listed below can cause your bid not to be read.

I. BID SECURITY

- A. The bid security must be in the minimum amount of 5% of the total bid amount including all add alternates (do not deduct the amount of deduct alternates). Bid security shall be in the form of a cashier’s check, a certified check drawn on a FDIC insured bank in Iowa or drawn on a FDIC insured bank chartered under the laws of the United States; or a certified share draft drawn on a credit union in Iowa or chartered under the laws of the United States; or a bid bond executed by a corporation authorized to contract as a surety in Iowa or satisfactory to the Jurisdiction.
- B. The bid bond must be submitted on the enclosed Bid Bond form as no other bid bond forms are acceptable. All signatures on the bid bond must be original signatures in ink; facsimile (fax) of any signature on the bid bond is not acceptable.
- C. Bid security other than said bid bond shall be in accordance with Chapter 468.35 of the Iowa Code.

II. SUBMISSION OF THE PROPOSAL AND IDENTITY OF BIDDER

- A. The proposal shall be sealed in an envelope, properly identified as the Proposal with the project title and the name and address of the bidder and deposited with the Jurisdiction at or before the time and at the place provided in the Notice to Bidders. It is the sole responsibility of the bidder to see that its proposal is delivered to the Jurisdiction prior to the time for opening bids, along with the appropriate bid security sealed in the separate envelope identified as Bid Security and attached to the outside of the bid proposal envelope. Any proposal received after the scheduled time for the receiving of proposals will be returned to the bidder unopened and will not be considered.
- B. The following documents shall be completed, signed and returned in the Proposal envelope. The bid cannot be read if any of these documents are omitted from the Proposal envelope.
 - 1. PROPOSAL – Complete each of the following parts:
 - Part B – Acknowledgment of Addenda, if any have been issued;
 - Part C – Bid Items, Quantities and Prices
 - Part F – Additional Requirements;

ITEM NO.	DESCRIPTION OF ATTACHMENT
1.	NONE

- Part G – Identity of Bidder;

Sign the proposal. The signature on the proposal and all proposal attachments must be an original signature in ink signed by the same individual who is the Company Owner or an authorized Officer of the Company; copies or facsimile of any signature will not be accepted.

The following documents must be submitted as printed. No alterations, additions, or deletions are permitted. If the Bidder notes a requirement in the contract documents which the Bidder believes will require a conditioned or unsolicited alternate bid, the Bidder must immediately notify the Engineer in writing. The Engineer will issue any necessary interpretation by an addendum.

- C. The general provisions and covenants, Division 1 of the 2024 SUDAS Standard Specifications are modified as follows:
 - 1. Section 1020.1.09B, Unit Price Attachment.
A computer-generated unit price attachment may be submitted by the Bidder as specified by this Section.

III. PROSECUTION AND PROGRESS OF THE WORK

- A. The work is located in Drainage District No. 57, Cerro Gordo County, Iowa,
Work on the repair or improvement shall commence upon approval of the contract by the Drainage District Trustees, and as stated in the Notice to Proceed. All work under the Contract must be substantially complete on or before September 30, 2024. Damages in the amount of \$500.00 per day will be assessed for each day the project remains incomplete.
- B. Community Events.
none
- C. Each successful bidder will be required to furnish a corporate surety bond in an amount equal to 100% of its contract price. Said bond shall be issued by a responsible surety approved by Drainage District No. 57, and shall guarantee the faithful performance of the contract and the terms and conditions therein contained and shall guarantee the prompt payment of all material and labor, and protect and save harmless Drainage District No. 57 from claims and damages of any kind caused by the operations of the contract and shall also guarantee the maintenance of the improvement caused by failures in materials and construction for a period of one year from and after acceptance of the contract.
- D. The Drainage District No. 57, in accordance with Title VI of the Civil Rights Act of 1964, 78 Stat. 252, 42U.S.C. 2000d to 2000d-4 and title 49 Code of Federal Regulations, Department of Transportation, Subtitle A, Office of the Secretary, Part 21, Nondiscrimination in Federally-assisted programs of the Department of Transportation issued pursuant to such Act, hereby notifies all bidders that it will affirmatively insure that in any contract entered into pursuant to this advertisement, minority business enterprises will be afforded full opportunity to submit bids in response to this invitation and will not be discriminated against on the grounds of race, color, or national origin in consideration for an award.

IV. PREFERENCE OF PRODUCTS AND LABOR

- A. In accordance with Iowa statutes, a resident bidder shall be allowed a preference as against a nonresident bidder from a state or foreign country if that state or foreign country gives or requires any preference to bidders from that state or foreign country, including but not limited to any preference to bidders, the imposition of any type of labor force preference, or any other form of preferential treatment to bidders or laborers from that state or foreign country. The preference allowed shall be equal to the preference given or required by the state of foreign country in which the nonresident bidder is a resident. In the instance of a resident labor force preference, a nonresident bidder shall apply the same resident labor force preference to a public repair in this state as would be required in the construction of a public repair by the state or foreign country in which the nonresident bidder is a resident.

V. TAXES

- A. The County Auditor will issue a sales tax exemption certificate to the Contractor for all materials purchased on the project. The County Auditor will issue the appropriate exemption certificates and authorization letters to the Contractor and all subcontractors completing work on the project. Tax exemption certificates are applicable only for the specific project for which the tax exemption certificate is issued.
- B. The Contractor shall provide a listing to the County identifying all appropriate subcontractors qualified for use of the tax exemption certificate. The Contractor and subcontractors may make copies of the certificate and provide to each supplier providing construction material a copy of the tax exemption certificate.
- C. Income Tax:
 - 1. Successful Bidder is subject to payment of Iowa income tax on income from this work in amounts prescribed by law.
 - 2. If successful bidder is a non-Iowa partnership, individual or association, he shall furnish evidence prior to execution of contract that bond or securities have been posted with the Iowa Department of Revenue in the amount required by law.

******END OF SECTION******

SECTION 00410 - PROPOSAL

Open Channel Cleanout
Drainage District No. 57
Cerro Gordo County, Iowa

PROPOSAL: PART A – SCOPE

Drainage District No. 57, Cerro Gordo County, Iowa, hereinafter called the “Jurisdiction”, has need of a qualified contractor to complete the work comprising the below referenced repair or improvement. The undersigned Bidder hereby proposes to complete the work comprising the below referenced repair or improvement as specified in the contract documents, which are officially on file with the Jurisdiction, in the office of the County Auditor, at the prices hereinafter provided in Part C of the Proposal, for the following described repairs:

PROJECT DESCRIPTION:

Construction of approximately 21.5 stations of open ditch excavation, 21.5 stations of spoil bank leveling, 21.5 stations of open ditch seeding and fertilizing, riprap placement, repairs to surface drainpipes and tile extension pipes, and all other miscellaneous items related thereto.

All bidders are required to complete “Proposal, attachment C, Bid Items and Quantities” to be considered for award.

The Board of Supervisors acting as Trustees will select any or no bid that is in the best interest of the Drainage District and the County Secondary Road Department.

PROPOSAL: PART B – ACKNOWLEDGMENT OF ADDENDA

The Bidder hereby acknowledges that all addenda become a part of the contract documents when issued, and that each such addendum has been received and utilized in the preparation of this bid. The Bidder hereby acknowledges receipt of the following addenda by inserting the number of each addendum in the blanks below:

ADDENDUM NUMBER _____ ADDENDUM NUMBER _____
ADDENDUM NUMBER _____ ADDENDUM NUMBER _____

and certifies that said addenda were utilized in the preparation of this bid.

PROPOSAL: PART C – BID ITEMS AND QUANTITIES

UNIT BID PRICE CONTRACTS: The Bidder must provide the Unit Bid Price, the Total Bid Price, any Alternate Prices and the Total Construction Costs on the Proposal Attachment: Part C – Bid Items and Quantities. In case of discrepancy, the Unit Bid Price governs. The quantities shown on the Proposal Attachment: Part C – Bid Items and Quantities are approximate only but are considered sufficiently adequate for the purpose of comparing bids. The Total Construction Cost shall be used only for the comparison of bids. The jurisdiction shall only use the Total Construction Cost for determining the sufficiency of the bid security.

PROPOSAL: PART D – GENERAL

The Bidder hereby acknowledges that the Jurisdiction, in advertising for public bids for this project reserves the right to:

1. Reject any or all bids. Award of the contract, if any, to be to the lowest responsible, responsive bidder; and

2. Reject any or all alternates in determining the items to be included in the contract. Designation of the lowest responsible, responsive bidder to be based on comparison of the total bid only, not including any alternates; and
3. Make such alterations in the contract documents or in the proposal quantities as it determines necessary in accordance with the contract documents after execution of the contract. Such alterations shall not be considered a waiver of any conditions of the contract documents, and shall not invalidate any of the provisions thereof; and

The Bidder hereby agrees to:

1. Enter into a contract, if this proposal is selected, in the form approved by the Jurisdiction, provide proof of registration with the Iowa Division of Labor in accordance with Chapter 91C of the Iowa Code, and furnish a performance, maintenance, and payment bond; and
2. Forfeit bid security, not as a penalty but as liquidated damages, upon failure to enter into such contract and/or to furnish said bond; and
3. Commence the work upon written Notice to Proceed, and
4. Substantially complete the work on or before September 30, 2024, and
5. Pay liquidated damages for noncompliance with said completion provisions at the rate of Five Hundred dollars (\$500.00) for each calendar day thereafter that the work remains incomplete.

PROPOSAL: PART E – NON-COLLUSION AFFIDAVIT

The Bidder hereby certifies:

1. That this proposal is not affected by, contingent on, or dependent on any other proposal submitted for any improvement with the Jurisdiction; and
2. That no individual employed by the Bidder has employed any person to solicit or procure the work on this project, nor will any employee of the Bidder make any payment or agreement for payment of any compensation in connection with the procurement of this project; and
3. That no part of the bid price received by the Bidder was or will be paid to any person, corporation, firm, association, or other organization for soliciting the bid, other than the payment of their normal compensation to persons regularly employed by the Bidder whose services in connection with the construction of the project were in the regular course of their duties for the Bidder; and
4. That this proposal is genuine and not collusive or sham; that the Bidder has not colluded, conspired, connived, or agreed, directly or indirectly, with any bidder or person, to submit a sham bid or to refrain from bidding, and has not in any manner, directly or indirectly, sought, by agreement or collusion, or communication or conference, with any person, to fix the bid price of the Bidder or of any other bidder, and that all statements in this proposal are true; and
5. That the individual(s) executing this proposal have the authority to execute this proposal on behalf of the Bidder.

PROPOSAL: PART F – ADDITIONAL REQUIREMENTS

The Bidder hereby agrees to comply with the additional requirements listed below which are included in this proposal and identified as proposal attachments:

ITEM NO.	DESCRIPTION OF ATTACHMENT
1.	None

PROPOSAL: PART G - IDENTITY OF BIDDER

The bidder shall indicate whether the bid is Submitted by a/an:

Individual,
Sole Proprietorship

Bidder

Partnership

Signature

Corporation

By

Name (Print/Type)

Limited Liability Company

Title

Joint-venture; all parties must join-in and
execute all documents

Street Address

Other

City, State, Zip Code

The bidder shall enter its Public
Registration Number ____ - ____
issued by the Iowa Commissioner of Labor
Pursuant Section 91C.5 of the Iowa Code.

Telephone Number

Type or print the name and title of the company's
owner, president, CEO, etc. if a different person
than entered above

Failure to provide said Registration
Number shall result in the bid being read
under advisement. A contract will not be
executed until the Contractor is registered.

Name

Title

NOTE: The signature on this proposal must be an original signature in ink; copies, facsimiles, or electronic signatures will not be accepted.

All bidders must submit the following completed form to the governmental body requesting bids per 875 Iowa Administrative Code Chapter 156.

Bidder Status Form

To be completed by all bidders

Part A

Please answer "Yes" or "No" for each of the following:

- Yes No My company is authorized to transact business in Iowa.
(To help you determine if your company is authorized, please review the worksheet on the next page).
- Yes No My company has an office to transact business in Iowa.
- Yes No My company's office in Iowa is suitable for more than receiving mail, telephone calls, and e-mail.
- Yes No My company has been conducting business in Iowa for at least 3 years prior to the first request for bids on this project.
- Yes No My company is not a subsidiary of another business entity or my company is a subsidiary of another business entity that would qualify as a resident bidder in Iowa.
- If you answered "Yes" for each question above, your company qualifies as a resident bidder. Please complete Parts B and D of this form.
- If you answered "No" to one or more questions above, your company is a non-resident bidder. Please complete Parts C and D of this form.

To be completed by resident bidders

Part B

My company has maintained offices in Iowa during the past 3 years at the following addresses:

Dates: _____ to _____ Address: _____
(mm/dd/yyyy) City, State, Zip: _____

Dates: _____ to _____ Address: _____
(mm/dd/yyyy) City, State, Zip: _____

Dates: _____ to _____ Address: _____
(mm/dd/yyyy) City, State, Zip: _____

You may attach additional sheet(s) if needed.

To be completed by non-resident bidders

Part C

- Name of home state or foreign country reported to the Iowa Secretary of State: _____
- Does your company's home state or foreign country offer preferences to bidders who are residents? Yes No
- If you answered "Yes" to question 2, identify each preference offered by your company's home state or foreign country and the appropriate legal citation.

You may attach additional sheet(s) if needed.

To be completed by all bidders

Part D

I certify that the statements made on this document are true and complete to the best of my knowledge and I know that my failure to provide accurate and truthful information may be reason to reject my bid.

Firm Name: _____
Signature: _____ Date: _____

Worksheet: Authorization to Transact Business

This worksheet may be used to help complete Part A of the Resident Bidder Status form. If at least one of the following describes your business, you are authorized to transact business in Iowa.

- Yes No My business is currently registered as a contractor with the Iowa Division of Labor.
- Yes No My business is a sole proprietorship and I am an Iowa resident for Iowa income tax purposes.
- Yes No My business is a general partnership or joint venture. More than 50 percent of the general partners or joint venture parties are residents of Iowa for Iowa income tax purposes
- Yes No My business is an active corporation with the Iowa Secretary of State and has paid all fees required by the Secretary of State, has filed its most recent biennial report, and has not filed articles of dissolution.
- Yes No My business is a corporation whose articles of incorporation are filed in a state other than Iowa, the corporation has received a certificate of authority from the Iowa Secretary of State, has filed its most recent biennial report with the Secretary of State, and has neither received a certificate of withdrawal from the Secretary of state nor had its authority revoked.
- Yes No My business is a limited liability partnership which has filed a statement of qualification in this state and the statement has not been canceled.
- Yes No My business is a limited liability partnership which has filed a statement of qualification in a state other than Iowa, has filed a statement of foreign qualification in Iowa and a statement of cancellation has not been filed.
- Yes No My business is a limited partnership or limited liability limited partnership which has filed a certificate of limited partnership in this state, and has not filed a statement of termination.
- Yes No My business is a limited partnership or a limited liability limited partnership whose certificate of limited partnership is filed in a state other than Iowa, the limited partnership or limited liability limited partnership has received notification from the Iowa Secretary of state that the application for certificate of authority has been approved and no notice of cancellation has been filed by the limited partnership or the limited liability limited partnership.
- Yes No My business is a limited liability company whose certificate of organization is filed in Iowa and has not filed a statement of termination.
- Yes No My business is a limited liability company whose certificate of organization is filed in a state other than Iowa, has received a certificate of authority to transact business in Iowa and the certificate has not been revoked or canceled.

Open Channel Cleanout
 Drainage District No. 57
 Cerro Gordo County, Iowa

PROPOSAL ATTACHMENT: PART C – BID ITEMS AND QUANTITIES

This is a UNIT BID PRICE CONTRACT. The bidder must provide the Unit Bid Price, the total Bid Price, and the Total Bid Amount; in case of discrepancy, the Unit Bid Price governs. The Quantities shown on the Proposal Attachment: Part C – Bid Items and quantities are approximate only but are considered sufficiently adequate for the purpose of comparing bids. The Jurisdiction shall only use the Total Bid Amount for comparison of bids.

DIVISION 1 - OPEN CHANNEL CLEANOUT

ITEM	DESCRIPTION	ESTIMATED UNITS	UNITS	UNIT PRICE	AMOUNT
1	OPEN DITCH EXCAVATION	21.5	STA	\$	\$
2	SPOIL BANK LEVELING (TWO SIDES)	17	STA	\$	\$
3	SPOIL BANK LEVELING (ONE SIDE)	3.25	STA	\$	\$
4	OPEN DITCH SEEDING AND FERTILIZING	21.5	STA	\$	\$
5	CMP SURFACE DRAIN, 24" DIA.	40	LF	\$	\$
6	CMP SURFACE DRAIN APRON, 24" DIA.	1	EA	\$	\$
7	CMP TILE EXTENSION, 12" DIA.	20	LF	\$	\$
8	ANIMAL GUARDS, 12" DIA.	1	EA	\$	\$
9	GEOTEXTILE FABRIC	25	SY	\$	\$
10	CLEARING AND GRUBBING	1	LS	\$	\$
11	RIPRAP, IDOT CLASS E	25	TN	\$	\$
12	FENCE CUTS	1	EA	\$	\$
13	REMOVAL OF FENCE, FIELD	100	LF	\$	\$
14	MOBILIZATION	1	LS	\$	\$

DIVISION 1 - AMOUNT BID \$ _____

NOTE: IT IS UNDERSTOOD THAT THE ABOVE QUANTITIES ARE ESTIMATED FOR THE PURPOSE OF THIS BID. ALL QUANTITIES ARE SUBJECT TO REVISION BY THE DISTRICT. QUANTITY CHANGES WHICH AMOUNT TO TWENTY (20) PERCENT OR LESS OF THE TOTAL BID SHALL NOT AFFECT THE UNIT PRICE BID.

 Bidder Name

SECTION 00420 - BID BOND

Open Channel Cleanout
Drainage District No. 57
Cerro Gordo County, Iowa

KNOW ALL BY THESE PRESENTS:

That we, _____, as Principal, and _____, as Surety, are held and firmly bound unto, Drainage District No. 57, Cerro Gordo County, Iowa as Obligee, (hereinafter referred to as "the Jurisdiction"), in the penal sum of _____ dollars (\$), lawful money of the United States, for which payment said Principal and Surety bind themselves, their heirs, executors, administrators, successors, and assigns jointly and severally, firmly by these presents.

The condition of the above obligation is such that whereas the Principal has submitted to the Jurisdiction a certain proposal, in a separate envelope, and hereby made a part hereof, to enter into a contract in writing, for the following described repairs;

PROJECT DESCRIPTION:

Construction of approximately 21.5 stations of open ditch excavation, 21.5 stations of spoil bank leveling, 21.5 stations of open ditch seeding and fertilizing, riprap placement, repairs to surface drainpipes and tile extension pipes, and all other miscellaneous items related thereto.

All bidders are required to complete "Proposal, attachment C, Bid Items and Quantities" to be considered for award.

The Board of Supervisors acting as Trustees will select any or no bid that is in the best interest of the Drainage District and the County Secondary Road Department.

The Surety hereby stipulates and agrees that the obligations of said Surety and its bond shall be in no way impaired or affected by any extension of the time within which the Jurisdiction may accept such bid or execute such Contract; and said Surety does hereby waive notice of any such extension.

In the event that any actions or proceedings are initiated with respect to this Bond, the parties agree that the venue thereof shall be Cerro Gordo County, State of Iowa. If legal action is required by the Jurisdiction against the Surety or Principal to enforce the provisions of the bond or to collect the monetary obligation incurring to the benefit of the Jurisdiction, the Surety or Principal agrees to pay the Jurisdiction all damages, costs, and attorney fees incurred by enforcing any of the provisions of this Bond. All rights, powers, and remedies of the Jurisdiction hereunder shall be cumulative and not alternative and shall be in addition to all rights, powers and remedies given to the Jurisdiction, by law. The Jurisdiction may proceed against Surety for any amount guaranteed hereunder whether action is brought against Principal or whether Principal is joined in any such action or actions or not.

NOW, THEREFORE, if said proposal by the Principal be accepted, and the Principal shall enter into a contract with Jurisdiction in accordance with the terms of such proposal, including the provision of insurance and of a bond as may be specified in the contract documents, with good and sufficient surety for the faithful performance of such contract, for the prompt payment of labor and material furnished in the prosecution thereof, and for the maintenance of said improvements as may be required therein, then this obligation shall become null and void; otherwise, the Principal shall pay to the Jurisdiction the full amount of the bid bond, together with court costs, attorney's fees, and any other expense of recovery.

Signed and sealed this _____ day of _____, 20__ .

SURETY:

PRINCIPAL:

By _____
 Surety Company

 Signature Attorney-in-Fact/Officer

 Name of Attorney-in-Fact/Officer

 Company Name

 Company Address

 City, State, Zip Code

 Company Telephone Number

By _____
 Bidder

 Signature

 Name (Print/Type)

 Title

 Address

 City, State, Zip Code

 Telephone Number

NOTE: All signatures on this bid bond must be original signatures in ink; copies or facsimile of any signature will not be accepted. This bond must be sealed with the Surety's raised, embossing seal or official adhesive seal. The Certificate or Power of Attorney accompanying this bond must be valid on its face and sealed with the Surety's raised, embossing seal or official adhesive seal.

SECTION 00500 - CONTRACT

Open Channel Cleanout
Drainage District No. 57
Cerro Gordo County, Iowa

THIS CONTRACT, made and entered into at _____
this _____ day of _____, by and between the Drainage District No. 57 Cerro
Gordo County hereinafter called the "Jurisdiction", and _____, hereinafter called the
"Contractor".

WITNESSETH:

The Contractor hereby agrees to complete the work comprising the Main Open Ditch Repairs as specified in the contract documents, which are officially on file with the Jurisdiction, in the office of the County Auditor, 220 N. Washington Ave., Mason City, Iowa. This contract includes all such contract documents. All work under this contract shall be constructed in accordance with the SUDAS Standard Specifications, 2024 Edition, and as further modified by the supplemental specifications and special provisions included in said contract documents, and the Contract Attachment which is attached hereto. The Contractor further agrees to complete the work in strict accordance with said contract documents, and to guarantee the work as required by law, for the time required in said contract documents, after its acceptance by the Jurisdiction.

This contract is awarded and executed for completion of the work specified in the contract documents for the bid prices shown on the Contract Attachment: Bid Items and Quantities which were proposed by the Contractor in its proposal submitted in accordance with the Notice to Bidders and Notice of Public Hearing for the following described repairs:

PROJECT DESCRIPTION:

Construction of approximately 21.5 stations of open ditch excavation, 21.5 stations of spoil bank leveling, 21.5 stations of open ditch seeding and fertilizing, riprap placement, repairs to surface drainpipes and tile extension pipes, and all other miscellaneous items related thereto.

The Contractor agrees to perform said work for and in consideration of the Jurisdiction's payment of the bid amount of _____ dollars (\$ _____), which amount shall constitute the required amount of the performance, maintenance, and payment bond. The Contractor hereby agrees to commence work as stated in the written Notice to Proceed; and substantially complete the work on or before September 30, 2024; and to pay liquidated damages for noncompliance with said completion provisions at a rate of Five Hundred dollars (\$500.00) for each calendar day that the work remains incomplete.

IN WITNESS WHEREOF, the Parties hereto have executed this instrument, in triplicate on the date first shown written.

JURISDICTION:
Cerro Gordo County Board of Supervisors acting as
Trustees

CONTRACTOR:

By _____
Lori Meacham Ginapp, Cerro Gordo County Board
Chair

(Seal)
ATTEST:

By _____
Contractor's Contact Name
Contractor's Title

Adam Wedmore, Cerro Gordo County Auditor

Street Address

City, State, Zip Code

Telephone

CONTRACTOR PUBLIC REGISTRATION INFORMATION To Be Provided By:

1. All Contractors: The Contractor shall enter its Public Registration No. _____ issued by the Iowa Commissioner of Labor pursuant to Section 91C.5 of the Iowa Code.
2. Out-of-State Contractors:
 - A. Pursuant to Section 91C.7 of the Iowa Code, an out-of-state contractor, before commencing a contract in excess of five thousand dollars in value in Iowa, shall file a bond with the division of labor services of the department of workforce development. The contractor should contact 515-242-5871 for further information. Prior to contract execution, the Jurisdictional Engineer may forward a copy of this contract to the Iowa Department of Workforce Development as notification of pending construction work. It is the contractor’s responsibility to comply with said Section 91C.7 before commencing this work.
 - B. Prior to entering into contract, the designated low bidder, if it be a corporation organized under the laws of a state other than Iowa, shall file with the Jurisdictional Engineer a certificate from the Secretary of the State of Iowa showing that it has complied with all the provisions of Chapter 490 of the Code of Iowa, or as amended, governing foreign corporations. For further information contact the Iowa Secretary of State Office at 515-281-5204.

Bond No. _____

Name of Surety _____

NOTE: All signatures on this contract must be original signatures in ink; copies or facsimile of any signature will not be accepted.

CORPORATE ACKNOWLEDGMENT

State of _____)
 _____) SS
 _____ County)

On this ____ day of _____, 20____, before me, the undersigned, a Notary Public in and for the State of _____, personally appeared _____ and _____, to me known, who, being by me duly sworn, did say that they are the _____, and _____, respectively, of the corporation executing the foregoing instrument; that (no seal has been procured by) (the seal affixed thereto is the seal of) the corporation; that said instrument was signed (and sealed) on behalf of the corporation by authority of this Board of Directors; that _____ and _____ acknowledged the execution of the instrument to be the voluntary act and deed of the corporation, by it and by them voluntarily executed.

 Notary Public in and for the State of _____
 My commission expires _____ 20, _____

PARTNERSHIP ACKNOWLEDGMENT

State of _____)
_____) SS
_____ County)

On this ____ day of _____, 20 ____, before me, the undersigned, a Notary Public in and for the State of _____, personally appeared _____ to me personally known, who being by me duly sworn, did say that the person is one of the partners of _____, a partnership, and that the instrument was signed on behalf of the partnership by authority of the partners and the partner acknowledged the execution of the instrument to be the voluntary act and deed of the partnership by it and by the partner voluntarily executed.

Notary Public in and for the State of _____
My commission expires _____ 20, _____

INDIVIDUAL ACKNOWLEDGMENT

State of _____)
_____) SS
_____ County)

On this ____ day of _____, 20 ____, before me, the undersigned, a Notary Public in and for the State of _____, personally appeared _____ and _____, to me known to be the identical person(s) named in and who executed the foregoing instrument, and acknowledged that (he) (she) (they) executed the instrument as (his) (her) (their) voluntary act and deed.

Notary Public in and for the State of _____
My commission expires _____ 20, _____

LIMITED LIABILITY COMPANY ACKNOWLEDGMENT

State of _____)
_____) SS
_____ County)

On this ____ day of _____, 20 ____, before me a Notary Public in and for said county, personally appeared _____, to me personally known, who being by me duly sworn did say that person is _____ of said _____, that (the seal affixed to said instrument is the seal of said OR no seal has been procured by the said) _____, and that said instrument was signed and sealed on behalf of the said _____, by authority of its managers and the said _____ acknowledged the execution of said instrument to be the voluntary act and deed of said _____, by it voluntarily executed.

Notary Public in and for the State of _____
My commission expires _____ 20, _____

CONTRACT ATTACHMENT: ITEM 1: GENERAL - NONE

CONTRACT ATTACHMENT: ITEM 2: BID ITEMS AND QUANTITIES

THIS CONTRACT IS AWARDED AND EXECUTED FOR COMPLETION OF THE WORK SPECIFIED IN THE CONTRACT DOCUMENTS FOR THE BID PRICES TABULATED BELOW AS PROPOSED BY THE CONTRACTOR IN ITS PROPOSAL SUBMITTED IN ACCORDANCE WITH NOTICE TO BIDDERS AND NOTICE OF PUBLIC HEARING. ALL QUANTITIES ARE SUBJECT TO REVISION BY THE JURISDICTION. THE JURISDICTION RESERVES THE RIGHT TO ADJUST QUANTITIES AS NECESSARY TO MAXIMIZE FUNDS BUDGETED FOR THIS PROJECT.

SECTION 00610 - PERFORMANCE, PAYMENT AND MAINTENANCE BOND

Open Channel Cleanout
Drainage District No. 57
Cerro Gordo County, Iowa

KNOW ALL BY THESE PRESENTS:

That we, _____, as Principal (hereinafter the "Contractor" or "Principal" and _____, as Surety are held and firmly bound unto _____, as Oblige (hereinafter referred to as "the Jurisdiction"), and to all persons who may be injured by any breach of any of the conditions of this Bond in the penal sum of _____ DOLLARS (\$ _____), lawful money of the United States, for the payment of which sum, well and truly to be made, we bind ourselves, our heirs, legal representatives and assigns, jointly or severally, firmly by these presents.

The conditions of the above obligations are such that whereas said Contractor entered into a contract with the Jurisdiction, bearing date the _____ day of _____, _____, hereinafter the "Contract" wherein said Contractor undertakes and agrees to construct the following described repairs:

PROJECT DESCRIPTION:

Construction of approximately 21.5 stations of open ditch excavation, 21.5 stations of spoil bank leveling, 21.5 stations of open ditch seeding and fertilizing, riprap placement, repairs to surface drainpipes and tile extension pipes, and all other miscellaneous items related thereto.

and to faithfully perform all the terms and requirements of said Contract within the time therein specified, in a good and workmanlike manner, and in accordance with the Contract Documents. Provided, however, that one year after the date of acceptance as complete of the work under the above referenced Contract, the maintenance portion of this Bond shall continue in force for the stated maintenance period.

It is expressly understood and agreed by the Contractor and Surety in this bond that the following provisions are a part of this Bond and are binding upon said Contractor and Surety, to-wit:

PERFORMANCE: The Contractor shall well and faithfully observe, perform, fulfill and abide by each and every covenant, condition and part of said Contract and Contract Documents, by reference made a part hereof, for the above referenced repairs, and shall indemnify and save harmless the Jurisdiction from all outlay and expense incurred by the Jurisdiction by reason of the Contractor's default of failure to perform as required. The Contractor shall also be responsible for the default or failure to perform as required under the Contract and Contract Documents by all its subcontractors, suppliers, agents, or employees furnishing materials or providing labor in the performance of the Contract.

PAYMENT: The Contractor and the Surety on this Bond are hereby agreed to pay all just claims submitted by persons, firms, subcontractors, and corporations furnishing materials for or performing labor in the performance of the Contract on account of which this Bond is given, including but not limited to claims for all amounts due for labor, materials, lubricants, oil, gasoline, repairs on machinery, equipment and tools, consumed or used by the Contractor or any subcontractor, wherein the same are not satisfied out of the portion of the contract price which the Jurisdiction is required to retain until completion of the repair, but the Contractor and Surety shall not be liable to said persons, firms, or corporations unless the claims of said claimants against said portion of the contract price shall have been established as provided by law. The Contractor and Surety hereby bind themselves to the obligations and conditions set forth in Chapter 573, Code of Iowa, which by this reference is made a part hereof as though fully set out herein.

MAINTENANCE: The Contractor and the Surety on this Bond hereby agree, at their own expense:

To remedy any and all defects that may develop in or result from work to be performed under the Contract within the of 1-year period for agricultural work, from the date of acceptance of the work under the Contract, by reason of defects in workmanship or materials used in construction of said work;

To keep all work in continuous good repair; and

To pay the Jurisdiction's reasonable costs of monitoring and inspection to assure that any defects are remedied, and to repay the Jurisdiction all outlay, and expense incurred as a result of Contractor's and Surety's failure to remedy any defect as required by this section.

Contractor's and Surety's agreement herein made extends to defects in workmanship or materials not discovered or known to the Jurisdiction at the time such work was accepted.

GENERAL: Every Surety on this Bond shall be deemed and held bound, any contract to the contrary notwithstanding, to the following provisions:

To consent without notice to any extension of time to the Contractor in which to perform the Contract;

To consent without notice to any change in the Contract or Contract Documents, which thereby increases the total contract price and the penal sum of this bond, provided that all such changes do not, in the aggregate, involve an increase of more than twenty percent of the total contract price, and that this bond shall then be released as to such excess increase; and

To consent without notice that this Bond shall remain in full force and effect until the Contract is completed, whether completed within the specified contract period, within an extension thereof, or within a period of time after the contract period has elapsed and the liquidated damage penalty is being charged against the Contractor.

The Contractor and every Surety on the bond shall be deemed and held bound, any contract to the contrary notwithstanding, to the following provisions:

That no provision of this Bond or of any other contract shall be valid which limits to less than five years after the acceptance of the work under the Contract the right to sue on this Bond.

That as used herein, the phrase "all outlay and expense" is not to be limited in any way but shall include the actual and reasonable costs and expenses incurred by the Jurisdiction including interest, benefits and overhead where applicable. Accordingly, "all outlay and expense" would include but not be limited to all contract or employee expense, all equipment usage or rental, materials, testing, outside experts, attorneys fees (including overhead expenses of the Jurisdiction's staff attorneys), and all costs and expenses of litigation as they are incurred by the Jurisdiction. It is intended the Contractor and Surety will defend and indemnify the Jurisdiction on all claims made against the Jurisdiction on account of Contractor's failure to perform as required in the Contract and Contract Documents, that all agreements and promises set forth in the Contract and Contract Documents, in approved change orders, and in this Bond will be fulfilled, and that the Jurisdiction will be fully indemnified so that it will be put into the position it would have been in had the Contract been performed in the first instance as required.

In the event the Jurisdiction incurs any "outlay and expense" in defending itself with respect to any claim as to which the Contractor or Surety should have provided the defense, or in the enforcement of the promises given by the Contractor in the Contract, Contract Documents, or approved change orders, or in the enforcement of the promises given by the Contractor and Surety in this Bond, the Contractor and Surety agree that they will make the Jurisdiction whole for all such outlay and expense, provided that the Surety's obligation under this bond shall not exceed 125% of the penal sum of this bond.

In the event that any actions or proceedings are initiated with respect to this Bond, the parties agree that the venue thereof shall be Cerro Gordo County, State of Iowa. If legal action is required by the Jurisdiction to enforce the provisions of this Bond or to collect the monetary obligation incurring to the benefit of the Jurisdiction, the Contractor and the Surety agree, jointly and severally, to pay the Jurisdiction all outlay, and expense incurred therefor by the Jurisdiction. All rights, powers, and remedies of the Jurisdiction hereunder shall be cumulative and not alternative and shall be in addition to all rights, powers and remedies given to the Jurisdiction, by law. The Jurisdiction may proceed against surety for any amount

guaranteed hereunder whether action is brought against the Contractor or whether Contractor is joined in any such action or actions or not.

NOW THEREFORE, the condition of this obligation is such that if said Principal shall faithfully perform all the promises of the Principal, as set forth and provided in the Contract, in the Contract Documents, and in this Bond, then this obligation shall be null and void, otherwise it shall remain in full force and effect.

When a work, term, or phrase is used in this Bond, it shall be interpreted or construed first as defined in this Bond, the Contract, or the Contract Documents; second, if not defined in the Bond, Contract, or Contract Documents, it shall be interpreted or construed as defined in applicable provisions of the Iowa Code; third, if not defined in the Iowa Code, it shall be interpreted or construed according to its generally accepted meaning in the construction industry; and fourth, if it has no generally accepted meaning in the construction industry, it shall be interpreted or construed according to its common or customary usage.

Failure to specify or particularize shall not exclude terms or provisions not mentioned and shall not limit liability hereunder. The Contract and Contract Documents are hereby made a part of this Bond.

(CON'T – PERFORMANCE, PAYMENT AND MAINTENANCE BOND)

Witness our hands, in triplicate, this _____ day of _____, _____.

Surety Countersigned By:

PRINCIPAL:

Signature of Iowa Resident Commission Agent as Prescribed by Chapter 515.52-57, Iowa Code. (Require only if Attorney-in-Fact is not also an Iowa Resident Commission Agent).

Contractor

By: _____

Signature

Name of Resident Commission Agent

Title

Company Name

SURETY:

Company Address

Surety Company

City, State, Zip Code

By: _____

Signature Attorney-in-Fact Officer

Company Telephone Number

Name of Attorney-in-Fact Officer

Company Name

Company Address

City, State, Zip Code

Company Telephone Number

NOTE: All signatures on this Performance, Maintenance and Payment Bond must be original signatures in ink; copies or facsimile of any signature will not be accepted. This bond must be sealed with the Surety’s raised, embossing seal or official adhesive seal. The Certificate or Power of Attorney accompanying this bond must be valid on its face and sealed with the Surety’s raised, embossing seal or official adhesive seal

Special Provisions
for
Open Channel Cleanout
Drainage District No. 57
Cerro Gordo County, Iowa

SPECIAL PROVISIONS

FOR

PART 1 - GENERAL REQUIREMENTS

INDEX

1. DEFINITION AND INTENT
2. DRAINAGE DISTRICT REQUIREMENTS REGARDING THE PROJECT CLOSEOUT AND THE RELEASE OF RETAINED FUNDS
3. GENERAL PROVISIONS AND COVENANTS
4. WORK REQUIRED
5. SALVAGE OF MATERIALS AND EQUIPMENT
6. PLANS AND SPECIFICATIONS
7. CONSTRUCTION FACILITIES
8. SUBMITTALS
9. STANDARDS AND CODES
10. SOIL BORINGS
11. CONSTRUCTION WITHIN RIGHT-OF-WAY
12. EMPLOYMENT PRACTICES
13. WORK HOURS/COMMUNITY EVENTS
14. DEFINITION AND INTENT
15. QUANTITIES
16. MAINTENANCE BOND AND WARRANTY PERIODS
17. MATERIALS
18. FIELDS TEST
19. MEASUREMENT AND PAYMENT
20. INCIDENTAL CONTRACT ITEMS

1. DEFINITION AND INTENT

- A. The Technical Specifications that apply to the materials and construction practices for this project are defined as follows:
 1. The 2024 Edition of the SUDAS Standard Specifications, except as modified by these Special Provisions to the Technical Specifications.
 2. Omissions of words or phrases such as “the Contractor shall”, “in accordance with”, “shall be”, “as noted on the Plans”, “according to the Plans”, “a”, “an”, “the” and “all” are unintentional; supply omitted words or phrases by inference.
 3. “Owner”, and “District” shall mean Drainage District No. 57, Cerro Gordo County, acting through the Board of Supervisors.

4. "Person" shall mean any individual, partnership, limited partnership, joint venture, society, association, joint stock company, corporation, limited liability company, estate, receiver, trustee, assignee, or referee, whether appointed by a court or otherwise, and any combination of individuals.
5. "Engineer" shall mean the Bolton & Menk, Inc., or designated agent.
6. The intent of the Technical Specifications is to describe the construction desired, performance requirements, and standards of materials and construction.
7. "Standard Drawings" shall mean the Figures bound within the SUDAS Standard Specifications and/or the Typical Drawings bound within the plans.
8. "Work" shall mean the work to be done and the equipment, supplies, and materials to be furnished under the contract unless some other meaning is indicated by the context.
9. "Or equal" shall follow manufacturers names used to establish standards and, if not stated, is implied.

B. Engineer: Bolton & Menk, Inc., 1609 US Hwy 18, Algona, Iowa 50511, (515) 395-3140.

2. DRAINAGE DISTRICT REQUIREMENTS REGARDING THE PROJECT CLOSEOUT AND THE RELEASE OF RETAINED FUNDS

- A. The general provisions and covenants, Division 1 of the 2024 SUDAS Standard Specifications are modified as follows:
- B. The provisions of Iowa Code Sections 468.100 -103 shall take precedence over any conflicting provisions of the contract documents. This includes the following provisions.
 1. Progress payments of 90% will be paid throughout the contract and no part of the retained funds owed contractor will be released until the statutory requirements for the closeout of a drainage district construction contract are completed. A finding of substantial contract completion will not result in a reduction in the amount of retained funds. However, it will be considered by the board of supervisors in determining the amount of liquidated damages to assess for a late-completed contract.
 2. When the engineer finds the work completed he will report and certify the satisfactory completion of the work to the board of supervisors. Upon receipt of this report the board will set a date and time of a contract completion hearing at which to consider the report and give notice to the affected landowners and drainage district all as per Code Section 468.101.
 3. Any party interested in the said district or the improvement thereof may file objections to said report and submit evidence tending to show said report should not be accepted. Any interested party having a claim for damages arising out of the construction of the improvements or repair shall file said claim with the board at or before the time fixed for hearing on completion of the contract.
 4. If it finds the work under the contract has been completed and accepted, the board shall compute the balance due, and if there are no liens on file against such balance, it shall enter of record an order directing the auditor to draw a warrant in favor of said contractor upon the levee or drainage fund of said district for such balance found to be due, but such warrants shall not be delivered to the contractor until the expiration of thirty days after the acceptance of the work.
 5. If any claims for damages have been filed as provided in Code Section 468.102, the board shall review said claims and determine said claims. If the determination by the board on any claim for damages results in a finding by the board that the damages resulting to the claimant were due to the negligence of the contractor, then the board shall provide for payment of said claim out of the remaining funds owing to the contractor. If the determination by the board results in a finding that the damages resulting to the claimant were not due to the negligence of the

contractor but resulted from unavoidable necessity in the performance of the contract, then the board shall allow for payment of said claim in the amount fixed by the board out of the funds in said drainage district.

6. If the board of supervisors determines at the hearing that the contractor has not completed the contract in full and that some uncompleted work remains to be done the board of supervisors may continue the hearing until that work is completed. The board may otherwise use its discretionary authority to close the hearing and to accept the work so as to allow for the release of the retained funds but to withhold a sum determined by the board to not be released to the contractor until the engineer reports that the uncompleted work has been completed. The funds held pending the finish of uncompleted work will then be released to be paid to the contractor with the balance of the retained funds at the appropriate time or to be paid immediately if the balance of the retained funds has already been paid.

3. GENERAL PROVISIONS AND COVENANTS

- A. The general provisions and covenants, Division 1 of the 2024 SUDAS Standard Specifications are modified as follows:
 1. Section 1020.1.09B, Unit Price Attachment.
A computer-generated unit price attachment may be submitted by the Bidder as specified by this Section.
 2. Section 1050.1.05 Shop Drawings, Certificates and Equipment Lists.
The Contractor shall submit a minimum of three (3) copies plus any additional required by the Contractor.

4. WORK REQUIRED

- A. Work under this contract includes all materials, equipment, transportation, traffic control and associated work for the construction of the Tile Facility Improvement as described in the Official Publication.
- B. This project consists of one contract for all work described.
- C. The construction work will need to be phased to facilitate timely construction of the improvements.

5. SALVAGE OF MATERIALS AND EQUIPMENT

- A. The Owner retains first right of refusal for retaining any existing materials removed by the construction.
- B. The Contractor shall carefully remove, in a manner to prevent damage, all materials and equipment specified or indicated as salvage. The Contractor shall protect, and store items specified.
- C. Any items damaged in removal, storage, or handling through carelessness or improper procedures shall be replaced by the Contractor in kind with new items.

6. PLANS AND SPECIFICATIONS

- A. The District will furnish 5 sets of plans and specifications to the Contractor after award of the contract. The Contractor shall compensate the Owner for printing costs for additional copies required.
- B. Provide one set of plans and specifications for each foreman and superintendent in charge of each crew on the job.

7. CONSTRUCTION FACILITIES

- A. Provide telephone numbers where Contractor's representative can be reached during workdays and on nights and weekends in event of emergency.
- B. The Contractor shall provide suitable storage facilities necessary for proper storage of materials and equipment.

- C. Do not store construction equipment, employee's vehicles, or materials on roads open to traffic. Location for storage of equipment by Contractors is subject to approval of Engineer.
- D. Provide and maintain suitable sanitary facilities for construction personnel for duration of work; remove upon completion of work.
- E. The Contractor will be required to make arrangements for all services required during the construction period and pay for such services at no additional cost to the Owner.

8. SUBMITTALS

- A. Provide construction schedule showing dates of starting and completing various portions of work.
- B. Submit the following information for Engineer's review. Provide 3 copies plus copies required by Contractor. This information shall be submitted to the Engineer at the preconstruction conference or at least 14 days prior to utilization of the particular item on this project.
 - 1. Testing reports.
 - 2. Manufacturer's data for materials that are to be permanently incorporated into the project.
 - 3. Details of proposed methods of any special construction required.
 - 4. Submit purchase orders and subcontracts without prices.
 - 5. Such other information as the Engineer may request to insure compliance with contract documents.
- C. Provide Traffic Control and staging plan (3 copies)

STANDARDS AND CODES

- A. Construct improvements with best present-day construction practices and equipment.
- B. Conform with and test in accordance with applicable sections of the following standards and codes.
 - 1. American Association of State Highway and Transportation Officials (AASHTO).
 - 2. American Society for Testing and Materials (ASTM).
 - 3. Iowa Department of Transportation Standard Specifications (Iowa DOT).
 - 4. American National Standards Institute (ANSI).
 - 5. American Water Works Association (AWWA).
 - 6. American Welding Society (AWS).
 - 7. Federal Specifications (FS).
 - 8. Iowa Occupational Safety and Health Act of 1972 (IOSHA).
 - 9. Manual of Accident Prevention in Construction by Associated General Contractors of America, Inc. (AGC).
 - 10. Standards and Codes of the State of Iowa and the local ordinances.
 - 11. Other standards and codes which may be applicable to acceptable standards of the industry for equipment, materials and installation under the contract.

10. SOIL BORINGS

- A. None

11. CONSTRUCTION WITHIN RIGHT-OF-WAYS

- A. All work on this project will be within Owner's Right-of-Way, Easements or Public Property.

12. EMPLOYMENT PRACTICES

- A. Neither the Contractor nor the Contractor’s subcontractors shall employ any person whose physical or mental condition is such that this employment will endanger the health and safety of anyone employed on the Project.
- B. The Contractor shall not commit any of the following employment practices and agrees to include the following clauses in any Subcontracts:
 - 1. To discharge from employment or refuse to hire any individual because of sex, race, color, religion, national origin, sexual orientation, marital status, age, or disability unless such disability is related to job performance of such person or employee.
 - 2. To discriminate against any individual in terms, conditions, or privileges or employment because of sex, race, color, religion, national origin, sexual orientation, marital status, age, or disability unless such disability is related to job performance of such person or employee.

13. WORK HOURS/COMMUNITY EVENTS

- A. The Contractor will be required to limit the Contractor’s work hours on the Project from 7:00 a.m. to 7:00 p.m., Monday through Saturday, unless otherwise directed by the Engineer.
- B. The following Community Events are scheduled. Contractor is required to coordinate with the Owner as needed to allow use of adjacent public property.
 - 1. None

14. DUST ABATEMENT

- A. The Contractor shall make a reasonable effort to assure dust does not become a problem. The Engineer reserves the right to stop Contractor’s operations whenever dust becomes a problem on the Project and direct the Contractor to revise operations to solve the dust problem.

15. QUANTITIES

- A. The Contractor is to realize some of the quantities on this Project are best estimates and may vary from actual conditions at time of construction of the Project. Quantities must be regarded as approximate only, and are given as a guide to the Bidder and for comparison of Bids. The Owner reserves the right to increase or decrease these quantities as designated in the Contract, and the Contractor will be paid for only as much work as the Contractor is required to do by the Owner at the unit price stated in the Proposal.

16. MAINTENANCE BOND AND WARRANTY PERIODS

- A. The requirements of the Payment, Performance and Maintenance Bond warranty period are modified as follows:
 - 1. To remedy any and all defects that may develop in or result from work to be performed under the Contract within a 1-year period for drainage repair or improvements, from the date of acceptance of the work under the Contract, by reason of defects in workmanship or materials used in construction of said work.

17. MATERIALS TESTS

- A. Material testing is as specified for construction and will be completed by an independent testing laboratory retained by the Contractor and approved by the Engineer. Testing shall meet the requirements of the SUDAS Standard Specifications.
- B. Coordinate all material testing with the Engineer.
- C. Provide transportation of all samples to the laboratory.

- D. Do not ship materials to the project site until laboratory tests have been furnished showing compliance of materials with specifications.
- E. Provide gradation and materials certifications for all granular materials. Certify that sources of Portland Cement and aggregates are Iowa DOT approved.
- F. Certify that materials and equipment are manufactured with applicable specifications.

18. FIELD TESTS

Testing shall meet the requirements of the SUDAS Standard Specifications. Owner/Contractor testing responsibility is as follows:

- A. Testing Responsibility
 - 1. Owner
 - (a) Division 2, Earthwork, Section 3.09 - Field Quality Control.
 - (b) Division 3, Trench and Trenchless Construction, Section 3.06 - Trench Compaction Testing.
- B. The contractor shall be responsible for testing that is required of the contractor by the SUDAS Standard Specifications.
- c. If test results do not meet those specified, the Contractor shall make necessary corrections and repeat testing to demonstrate compliance with the specifications. Contractor shall pay all costs for retesting.

19. MEASUREMENT AND PAYMENT

- A. Contract unit or lump sum prices are full compensation for furnishing all materials, equipment, tools, transportation, and labor necessary to construct and complete each item of work as specified. No separate payment will be made for work included in this project except as set forth in the bid item reference notes. Refer to the C sheets for bid items reference notes. All other items of work are incidental to construction.
- B. Payment for work done will be in accordance with estimates approved monthly by the Engineer and in Drainage Warrants issued by the Drainage District, which, if registered and stamped "not paid for want of funds ", shall bear interest at a rate fixed by the Board not to exceed the maximum set by law in accordance with Chapter 468 of the Code of Iowa, as amended. The Board reserves the right to issue Drainage District Improvement Certificates pursuant to Chapter 468 of the Code of Iowa, as amended, which certificates may be given in exchange for outstanding warrants issued to the Contractor or to the holder thereof. Said warrants to be surrendered, if called by the Board, in exchange for Drainage District Improvement Certificates which shall be taken by the Contractor or holder at par and shall bear interest at a rate fixed by the Board not to exceed the maximum set by law in accordance with Chapter 468 of the Code of Iowa, as amended.
- C. Progress payments will be made in an amount equal to ninety percent (90%) of the work completed. Final payment will be made not less than thirty (30) days after completion of the work and acceptance by the Board, subject to the conditions and in accordance with the provisions of Chapter 468 of the Code of Iowa, as amended.

20. INCIDENTAL CONTRACT ITEMS

- A. The following list includes major items that are incidental to the project and will not be paid for as separate bid items. Other items may be designated as incidental under certain bid items.

Connections to drain tile and pipes unless specified for separate payment
 Construction and removal of temporary field entrances and access roads
 Construction fencing
 Construction staging & phasing

Coordination and cooperation with affected property owners
Coordination and cooperation with Cerro Gordo County
Coordination and cooperation with other Contractors
Coordination and cooperation with other projects in the area
Coordination and cooperation with utility companies
Dewatering and handling storm water flow during construction
Dust control measures
Engineering Fabric
Excavation, verification and protection of existing utilities
Field testing
Finish grading
Full depth sawcutting of existing pavement
Grading for drainage outlets
Granular backfill and bedding for pipe installation
Granular surfacing removal
Maintenance and watering for seeding and sodding
Maintenance of erosion control measures, including silt removal
Material testing
Monitoring weather conditions
Mowing
Overhaul
Pipe and structure bedding material
Protection of existing utilities and light poles
Removing and reinstalling existing signs
Reseeding
Site cleanup/restoration
Temporary safety closures
Temporary sheeting and shoring

END OF SECTION

SPECIAL PROVISIONS
FOR
PART 2 – DRAINAGE DISTRICT IMPROVEMENTS/REPAIRS
INDEX

1. GENERAL
2. EXISTING UTILITIES
3. PROJECT SUPERVISION
4. COORDINATION WITH OTHERS
5. CONSTRUCTION LIMITS
6. CONSTRUCTION SCHEDULE
7. CONSTRUCTION PHASING
8. CONSTRUCTION STAKING
9. CONSTRUCTION SURVEY DOCUMENTATION & RESPONSIBILITIES OF ENGINEER AND CONTRACTOR
10. DISPOSAL
11. DEWATERING
12. TRAFFIC CONTROL
13. TEMPORARY FENCES
14. RESPONSIBILITY OF CONTRACTOR
15. EARTHWORK
16. SITE WORK AND LANDSCAPING

1. GENERAL

- A. Procedures outlined herein are not intended to fully cover all special construction procedures but are offered as an aid to the Contractor in planning work.
- B. Cooperate with the Owner and the Engineer to minimize inconvenience to property owners, other jurisdictions and motorists and to prevent delays in construction and interruption to continuous operation of utility services and site access.
- C. Provide adequate personnel and equipment to perform work within specified time of construction.
- D. Install and maintain orange safety fence around all open trenches or open structures when left unattended.
- E. Provide surface restoration and clean up as construction progresses.

2. EXISTING UTILITIES

- A. Location of utility lines, mains, cables and appurtenances shown on plans are from information provided by utility companies and records of the Owner.

- B. Prior to construction, contact all utility companies and have all utility lines and services located. The Contractor is responsible for excavating and exposing underground utilities to field verify their locations ahead of the work.
- C. Contractor is solely responsible for damage to utilities or private or public property due to utility disruption.
- D. The Contractor shall notify utility company immediately if utility infrastructure is damaged during construction.
- E. With the exception of water lines, utility companies will relocate utility infrastructure in direct conflict with line and grade of the work during construction. Support and protect all utilities that are not moved.
- F. Utility services are not generally shown on plans; protect and maintain services during construction. Notify Jurisdiction and affected property Jurisdictions 48 hours prior to any planned utility service interruptions.
- G. If utility work does occur during the construction period, work schedules from the Contractor and from the utility companies will be submitted to the Engineer for coordination to obtain mutually acceptable schedules, if possible.
- H. Existing utilities shall remain in substantially continuous operation during construction. Select the order and methods of construction that will not interfere with the operation of the utility systems. Interrupt utility services only with approval of Owner and Engineer.
- I. No claims for additional compensation or time extensions will be allowed to the Contractor for interference or delay caused by utility companies.

3. PROJECT SUPERVISION

- A. The Contractor shall be represented in person at the construction site at all times that construction operations are proceeding by a qualified superintendent or other designated, qualified representative capable of providing adequate supervision. The superintendent or representative must be duly authorized to receive and execute instructions, notices and written orders from the Engineer.
- B. Issues that arise during construction relating to traffic control and construction staging, etc. are the responsibility of the Contractor.
- C. Weekly progress meetings, if specified at the preconstruction conference, with the Contractor, Engineer and Owner will be held at the project site to review the updated project schedule and progress, coordinate activities, resolve conflicts and coordinate the construction work. The day and time for this meeting will be set at the preconstruction conference.
- D. Refer to Division 1 – General Provisions and Covenants, Section 1080 – Contractual Provisions, Part 1 – Prosecution and Progress of the Work, Section 1.10 Contractors Employees, Methods and Equipment for additional requirements.

4. COORDINATION WITH OTHERS

- A. Cooperate and coordinate construction with the Owner, utility companies, affected property Jurisdictions and other contractors working in vicinity of this project.
- B. It is the Contractors responsibility to schedule and coordinate work to minimize construction delays and conflicts.
- C. Coordinate with property owners prior to beginning work that will affect their parcel.

5. CONSTRUCTION LIMITS

- A. Confine the construction operations within the construction limits shown on the plans.

- B. Do not store equipment, vehicles or materials within the right-of-way of any roads open to traffic or on temporary access roads at any time.
- C. Areas disturbed outside of construction limits shall be restored at the Contractor's expense to the satisfaction of the Owner. Contractor shall protect trees, fences, and landscaping within the construction limits not marked as remove.

6. CONSTRUCTION SCHEDULE

- A. The Contractor will prepare and submit to the Engineer for approval a project schedule that will assure the completion of the project within the time specified.
- B. Adequate equipment and forces shall be made available by the Contractor to start work immediately upon receipt of the Notice to Proceed.
- C. Submit construction schedule at the preconstruction conference and periodically update it as requested by the Engineer.
- D. The Contractor shall be required to meet the final completion date as specified in the written Notice to Proceed.
- E. Notify the City, County, State and property owners at least 48 hours prior to any road closures.
 - 1. Notify all property owners, affected by the road closures by written notice placed on the front door. Include the following items in the notice:
 - The road name, location and proposed date of road closure
 - The estimated schedule for completion of work
 - The estimated date for reopening of the road

7. CONSTRUCTION PHASING

- A. Refer to construction staging and traffic control plans when included in construction plans.
- B. Include construction phasing on the required construction schedule submittal.

8. CONSTRUCTION STAKING

The Owner, or an authorized representative, will provide construction staking. The Contractor shall provide two Working Days written notice to the Engineer to begin requested survey, staking, or layout work. Subsequent staking shall require two working days' notice in advance of the staking needs. Contractor shall be responsible for layout of all other construction items including, but not limited to, traffic control, structure removal, pavement markings, seeding, inlet filters and silt fence. **One-time staking shall be provided. Any re-staking shall be paid for by the Contractor.**

Construction staking, provided by the Owner on the project, will include the following:

- A. HORIZONTAL AND VERTICAL CONTROL
 - 1. Locate and maintain all horizontal control points and vertical benchmarks as listed on the plan sheets that may be destroyed by the plan construction.
- B. REMOVAL LIMITS
 - 1. Locate removals and pavement, sidewalks, drives, structure, trees. Removals not authorized or outside of removal limits shall be at Contractor expense.
- C. DRAIN TILE, CULVERTS/STRUCTURES
 - 1. Offset grade stakes shall be provided for all structures and bends. Offset grade stakes shall also be provided 50' from both sides of a structure.

2. Centerline stakes for drain tile shall be provided in a manner which ensures a direct line of site between adjacent stakes.
- D. GRADE STAKING
1. Ditch grade at 100-foot intervals including grade breaks.
9. CONSTRUCTION SURVEY DOCUMENTATION & RESPONSIBILITIES OF ENGINEER AND CONTRACTOR
- A. Tie-ins with existing pavements and utilities shall be verified for correctness of alignment and elevation prior to construction staking. Any discrepancies discovered during this verification process will be brought to the attention of the Engineer for review and assistance with resolution prior to staking.
 - B. When survey work is done under traffic conditions, the traffic control shall be in place prior to commencement of survey work.
 - C. The Engineer will have a representative at the preconstruction conference to discuss construction staking.
 - D. The Owner and Engineer will not be responsible for delays due to lack of grade or line stakes unless the Contractor has given the Engineer a 48 hour notice that such stakes will be needed and the Contractor's work is being conducted in a satisfactory manner and at the specified rate of progress.
10. DISPOSAL
- A. Remove from project site and dispose of trees, shrubs, vegetation, excess soil excavation, rubbish, concrete, granular materials and other materials encountered as shown on plans and as specified. Excess soil excavation not designated for waste locations shall be disposed as directed by the Engineer.
 - B. Dispose of materials in accordance with applicable laws and ordinances. Disposal sites are subject to the review and approval of the Engineer.
 1. Dispose of broken concrete, asphalt, granular material, rubble, excess or unsuitable excavated material. Contractor is responsible for selecting disposal site.
 2. Cooperate with all applicable City, State and Federal agencies concerning disposal of materials.
 3. The Owner has the first right to any excess materials from construction.
11. DEWATERING
- A. Perform all construction work in dry conditions.
 - B. Submit dewatering methods to the Engineer for review. Obtain the Engineers approval on methods prior to construction.
 - C. Groundwater levels are subject to variation. No additional compensation will be permitted due to high groundwater conditions.
 - D. If excavation encounters only cohesive soils with no wet sand seams or layers, it may be possible to control water seepage by draining groundwater to temporary construction sumps and pumping it outside the perimeter of the excavation.
 - E. Do not pump water from open excavation in sand and gravel below the natural ground water level.
 - F. Maintain water levels 2 feet or more below the bottom of excavations in saturated cohesionless (sand and/or gravel) soils to prevent upward seepage, which could reduce subgrade support.
 1. Install dewatering system (well points or shallow wells) when working in cohesionless soils.
 2. Costs of installing and operating dewatering system must be approved by Owner before dewatering starts.
 - G. Provide for handling surface water encountered during construction.
 1. Prevent surface water from flowing into excavation, remove water as it accumulates.

2. Divert surface water and storm sewer flow around areas of construction.
 3. Do not use sanitary sewers for the disposal of trench water.
- H. Backfill pipe and structures prior to stopping dewatering operations. Do not lay pipe or construct concrete structures on excessively wet soils.
- I. The costs of handling both surface water and groundwater are incidental.

12. TRAFFIC CONTROL

- A. Furnish, erect and maintain traffic control devices as specified in the construction drawings and directed by the Engineer including signs, barrels, cones, and barricades to direct traffic and separate traffic from work areas. Traffic control shall be in place prior to the closing of any roads.
- B. Provide traffic control devices in accordance with the Iowa DOT Standard Specification, Section 2528, Traffic Control, and the latest edition of the Manual on Uniform Traffic Control Devices (MUTCD).
- C. Adjustments to the traffic control or the addition of flaggers will be required if, in the opinion of the Engineer, undue traffic congestion occurs.
- D. Provide continuous access for police, fire, and other emergency vehicles.

13. TEMPORARY FENCES

- A. Install temporary fencing around open excavations or material storage areas and as directed by Engineer to prevent access of unauthorized persons to construction areas.
- B. Provide orange plastic mesh safety fence with a nominal height of 48". Support fence securely on driven posts in vertical position without sagging.
 1. Materials: Iowa DOT Section 4188.03.
 2. Use unless required otherwise.
- C. Temporary fencing installed around open excavations or material storage areas is incidental to construction and will not be measured for payment.
- D. Remove temporary fencing upon completion of construction.

14. RESPONSIBILITY OF CONTRACTOR

- A. Supervision of the work.
- B. Protection of all property from injury or loss resulting from construction operations.
- C. Replace or repair objects sustaining any such damage, injury or loss to satisfaction of Owner and Engineer.
- D. Cooperate with Owner, Engineer, and representatives of utilities in locating underground utility lines and structures. Incorrect, inaccurate or inadequate information concerning location of utilities or structures shall not relieve the Contractor of responsibility for damage thereto caused by construction operations.
- E. Keep cleanup current with construction operations.
- F. Comply with all Federal, State, and the local laws and ordinances.

15. EARTHWORK

- A. Clearing and Grubbing
 1. Work shall be conducted in a manner which minimizes the inconvenience caused by the Work to adjacent landowners.
 2. Engineer has the authority to limit clearing and grubbing to specific areas until all Work in that area is complete.

3. Engineer has the authority to temporarily prohibit clearing and grubbing in an area for the purpose of allowing time for a crop to be harvested, if said temporary prohibition does not materially negatively affect the progress of the project.

B. Class 13 Excavation

1. Unless otherwise detailed on the plans or directed by the Engineer, excavation shall commence at the downstream end of the project and proceed upstream.
2. Unless otherwise detailed on the plans or as directed by the Engineer, no spoil shall be placed within public road right-of-way.
3. Contractor shall notify the County Engineer prior to commencing work within any County right of way. All work performed within County Right-of-Way shall be performed in compliance with County requirements.
4. Excessive over excavation and bottom width ditch expansion shall be avoided. Unless otherwise shown on the plans, spoil shall be removed uniformly from the ditch and shall be disposed of as it is excavated.
5. Unless otherwise shown on the plans, excavation shall be carried out from both sides of the ditch and spoil shall be placed in approximately equal amounts on both sides of the ditch.
6. Contractor shall fill and/or shape overbank washouts to reasonably conform to the ditch cross section plan design.

C. Spoil Bank Leveling

1. Spoil shall be shaped and sloped to a uniform cross section in compliance with the typical ditch cross section shown on the plans.

16. SITE WORK AND LANDSCAPING

A. Fence Removal

1. After the contract has been awarded the Engineer shall notify all landowners with property within the work limits that have fence which will interfere with the prosecution of the work.
2. Contractor shall give ten (10) days notice to Engineer prior to removing any livestock fencing. After the 10 day notice period has expired, Contractor may remove fence that interferes with the prosecution of the work.
3. Fence may be disposed of by burial within the work limits. Wire mesh shall be flattened. All fencing material disposed of by burying shall be buried to a depth of at least 4 feet below finished grade.

END OF SECTION

Supplemental Specifications

for

Open Channel Cleanout

Drainage District No. 57

Cerro Gordo County, Iowa

SUPPLEMENTAL SPECIFICATIONS

FOR

RURAL PUBLIC DRAINAGE REPAIRS AND IMPROVEMENTS

INDEX

THESE SUPPLEMENTAL SPECIFICATIONS ARE INTENDED TO PROVIDE DETAILED SPECIFICATIONS SPECIFIC TO RURAL DRAINAGE DISTRICT PROJECTS. THEY ARE TO BE CONSIDERED IN TANDEM WITH THE SUDAS SPECIFICATIONS AND WHERE IN CONFLICT THESE SUPPLEMENTAL SPECIFICATIONS SHALL APPLY. ALL OTHER DEFERENCE IS GIVEN TO THE PLAN NOTES, ESTIMATE REFERENCES AND THE SUDAS SPECIFICATIONS IN THAT ORDER.

PART 1 – GENERAL

- 1.01. DESCRIPTION OF WORK
- 1.02. SUBMITTALS
- 1.03. SUBSTITUTIONS
- 1.04. DELIVERY, STORAGE AND HANDLING
- 1.05. SCHEDULING AND CONFLICTS
- 1.06. SPECIAL REQUIREMENTS
- 1.07. MEASUREMENT AND PAYMENT

PART 2 – PRODUCTS

- 2.01. OPEN DITCH EXCAVATION
- 2.02. OPEN DITCH SEEDING AND FERTILIZING
- 2.03. OPEN DITCH SURFACE DRAIN AND TILE PIPES
- 2.04. REINFORCED CONCRETE PIPE TEES / ELBOWS / END CAPS / APRON SECTIONS / REDUCERS /
FIELD TILE CONNECTIONS
- 2.05. STEEL SHEET PILING
- 2.06. ENGINEERING FABRIC FOR UNDERLAYING RIPRAP REVETMENT
- 2.07. CONCRETE GROUT FOR RIPRAP REVETMENT
- 2.08. OPEN DITCH TEMPORARY SILT CURTAINS

PART 3 – EXECUTION

- 3.01. OPEN DITCH EXCAVATION
- 3.02. OPEN DITCH SPOIL BANK LEVELING
- 3.03. OPEN DITCH SEEDING AND FERTILIZING
- 3.04. OPEN DITCH SURFACE DRAIN AND TILE EXTENSION PIPES
- 3.05. REINFORCED CONCRETE PIPE TEES / ELBOWS / END CAPS / APRON SECTIONS / REDUCERS /
FIELD TILE CONNECTIONS
- 3.06. STEEL SHEET PILING
- 3.07. GEOTEXTILE FABRIC
- 3.08. CONCRETE GROUT FOR RIPRAP REVETMENT
- 3.09. EXPLORATORY INVESTIGATION
- 3.010. ADMINISTRATION OF EROSION MANAGEMENT PLAN
- 3.011. OPEN DITCH SILT CURTAINS

PART 1 – GENERAL

1.01. DESCRIPTION OF WORK

Additional work items for Drainage District Improvements / Repairs.

1.02. SUBMITTALS (IF NOT INCLUDED IN SUDAS SPECIFICATIONS)

- A. Open Ditch Seeding and Fertilizing: Provide all seed sacks with identification tags attached, Germination tests less than one year old required. Provide fertilizer bag tags or other proof of compliance.
- B. Open Ditch Surface Drain and Tile Extension Pipes: Provide manufacturer's certification of compliance with specification requirements for pipe, drain tile and appurtenances.
- C. Steel Sheet Pile: Provide manufacturer's shop drawings and certification of compliance with specification requirements for Steel Sheet Pile.
- D. Comply with Division 1 – General Provisions and Covenants.

1.03. SUBSTITUTIONS

- A. Open Ditch Surface Drains and Tile Extensions: Obtain prior approval for additions or changes in location, diameter and length of pipe shown on drawings or as otherwise required by Engineer.
- B. Comply with Division 1 – General Provisions and Covenants.

1.04. DELIVERY, STORAGE AND HANDLING

Comply with Division 1 – General Provisions and Covenants.

1.05. SCHEDULING AND CONFLICTS

Comply with Division 1 – General Provisions and Covenants.

1.06. SPECIAL REQUIREMENTS

1.07. MEASUREMENT AND PAYMENT

- A. Open Ditch Excavation:
 - 1. Measurement: Open ditch excavation shown on plans computed by using the average end area method using surveyed cross-sections for the preparation of the plans, to which a percentage has been added to allow for up to 0.5 feet of extra depth in the ditch bottom and for other necessary over-excavation. This percentage is shown in the estimate reference. No additional measurements will be made. The quantities of excavation on the drawings and in the Contract represent the final quantity of excavation for the completed work.
 - 2. Payment: Unit price per cubic yard for the quantity of open ditch excavation stated in the Proposal.

3. Includes: Construction of access roads, excavating and depositing spoil, overhaul, over excavation, removal of minor ditch bank sloughs, excavation to allow for placements of revetment, excavation of silt traps upstream of temporary open ditch silt curtains where specified, patrolling for sediment and removal in reaches previously cleaned, and finish shaping and sloping of the channel. Includes removal of friable ledge rock as can be accomplished using contractors planned equipment. Includes furnishing all equipment, tools, labor and incidentals necessary to complete the work.
4. Does not Include: Excavation of solid ledge rock or bedrock or necessary topsoil work when specified (Each will be paid under separate bid items or negotiated extra work).

B. Open Ditch Spoil Bank Leveling:

1. Measurement: Measure at 100 foot stations along centerline of ditch with no deduction for Public Road rights-of-way, intersecting open ditches, private crossings and the like. Measurement may in some circumstances apply to one side of open ditch.
2. Payment: Unit price per 100 foot station shall be full compensation for spoil shaped and sloped to a relatively uniform cross section in conformance with the typical leveled spoil bank cross section shown on the plans.
3. Includes: Deep tilling, rock removal (performed two (2) times) and disking, leveling and shaping deposited spoil both old and new to uniform cross-section on one side or both sides of the open ditch respective as specified. Includes furnishing all labor, equipment, tools and miscellaneous associated work necessary to complete item. Includes construction or reconstruction of road ditch dikes and field entrances and minor shaping and grading to maintain drainage on the field side of the spoil bank.
4. Does not Include: Necessary topsoil work when specified (Paid under separate bid items).

C. Open Ditch Seeding and Fertilizing:

1. Measurement: Measure at 100 foot stations along centerline of ditch with no deduction for public road rights-of-way, intersecting open ditches, private crossings and the like. No measurement of the area actually seeded will be taken.
2. Payment: Unit price per 100 foot stations shall be full compensation for seeding and fertilizing disturbed ditch banks on both sides of the open ditch at the rates specified in the contract documents.
3. Includes: Supplying seed sacks and tags and fertilizer tags or other evidence of compliance with the specs to the Engineer. All required seed treatments, any necessary seed bed preparation, labor, equipment, tools and miscellaneous associated work necessary to complete item on one side or both sides as specified.

D. Open Ditch Surface Drain and Tile Extension Pipes:

1. Measurement: Lineal foot by nominal pipe size.
2. Payment: Unit Price bid per lineal foot. Necessary extensions of drain tile to the tile outlet pipe or relays shall be paid at the unit price bid for applicable diameter tile outlet pipe for the actual length installed.
3. Includes: Providing log of tile extension and surface drain work to Engineer. Furnishing, handling, laying pipe materials, concrete collars, connecting bands, trench excavation, backfilling, removal and disposal of replaced material, administration of changes in pipe sizes, lengths and locations, movements of equipment throughout the work limits, and providing all materials, labor, equipment, tools and miscellaneous associated work to complete item. Also includes transportation, handling, restock and other associated fees for returning or adding pipe.
4. Does Not Include: Bedding rock where it is determined by the engineer to be needed to complete the work will be paid for separately under appropriate bid item.

E. Drainage Pipe Tees / Elbows / End Caps / Apron Section / Reducers / Field Tile Connections:

1. Measurement: Number of each by nominal size as bid.
2. Payment: Unit price for each by specified size.
3. Includes: All materials, labor, equipment, tools and miscellaneous associated work necessary to fabricate or extend or connect pipe or install appurtenances. For tees, elbows and reducers, price includes fabrication of the structure and installation only. All lengths of pipe shall be paid under the appropriate bid items. End caps and apron sections include the materials cost and their lengths are not included in the drainage pipe measurements for payment. Includes pipe bedding rock required to account for avoidable over excavation of the installation trenches depths or widths.
 - a. Tees: Stub pipe is assumed 1 LF in length.
 - b. Field Tile Connections < 12" Diameter: Includes furnishing up to 20 LF of Heavy Duty Corrugated Polyethylene Drainage Tubing.
 - c. Field Tile Connections \geq 12" Diameter: Includes field fabricating as needed of up to two standard length sections of RCP (The class to be the same or stronger as the receiving pipe) of the same or next larger standard size than the tile being connected. Length of RCP installed will be paid under the appropriate bid item for the size and class of pipe installed.
4. Does not Include: Bedding rock where it is determined by the engineer to be needed to complete the work will be paid for separately under appropriate bid item.

F. Steel Sheet Pile:

1. Measurement: Square foot of material.
2. Payment: Unit price per square foot of material furnished and installed to the plan lines shown on the plans.
3. Includes: Steel waler and other appurtenances, temporary guide structures, excess material to account for deformation of tops of sheet pile sheets and for other damages during construction, all materials, labor, equipment, tools and miscellaneous associated work necessary to construct or fabricate the sheet pile wall to the neat lines shown on the plans.
4. Does not Include: Payment will not be made for area of sheet pile which is accepted by engineer but installed short of plan lines.

G. Geotextile Fabric:

1. Measurement: Square yard of material placed.
2. Payment: Unit price per square yard of material placed as shown on the plans.
3. Includes: All materials, labor, equipment, tools and miscellaneous associated work necessary to place, shape, compact and grade the receiving earth surface for the installation of geotextile fabric. Includes cutting and overlaps. Includes anchoring work and materials.

H. Concrete Grout for Riprap Revetment:

1. Measurement: Cubic yard of material placed.
2. Payment: Unit price per cubic yard of material placed as shown on the plans.
3. Includes: All materials, labor, equipment, tools and miscellaneous associated work necessary to mix, transport and place and incorporate into the receiving riprap the concrete grout as shown on the plans. Includes brooming the grout into riprap and removing by broom excess grout from exposed surfaces of the riprap. When ready-mixed grout is furnished, the contractor shall furnish delivery tickets showing the time of loading and the quantities of materials used for each load of grout mix.

I. Exploratory Investigation:

1. Measurement: Hours spent locating existing tile and other underground facilities as shown on the plans or directed by the Engineer.
2. Payment: Unit price per hour for time spent locating existing tile and other underground facilities as shown on the plans or directed by the Engineer.
3. Includes: Excavator, operator, all labor, materials and appurtenant equipment necessary to locate existing tile and other underground facilities and to backfill all excavations.

4. Does not Include:

- a. Down time waiting for Engineer to review exploratory pit.
- b. Repair of tile lines damaged during the search not due to negligence as determined by Engineer.
- c. Necessary repairs will be paid separately as extra work.

J. Administration of Erosion Management Plan:

1. Measurement: Lump Sum item, no measurement will be made. Engineer will verify that efforts to comply with the plan have been made.
2. Payment: Paid as Lump Sum upon completion of the work. May be adjusted if engineer determines that efforts to comply with the plan requirements were not satisfactorily made.
3. Includes: Scouting installation locations of erosion controls, patrolling for maintenance of erosion controls, cleaning of silt fence, all labor, equipment, tools and miscellaneous work necessary to reasonably control erosion and pollution on the project site.

K. Open Ditch Silt Curtains:

1. Measurement: For each temporary silt curtain placed and removed.
2. Payment: For each temporary silt curtain placed and removed in compliance with the requirements of the Storm Water Erosion Management Plan.
3. Includes: All labor, material, equipment, tools and miscellaneous work necessary install and remove the Temporary Silt Curtain as described in the Storm Water Erosion Management Plan.
4. Does Not Include:
 - a. Excavation of sediment pit upstream of curtain paid for under open ditch excavation bid item.
 - b. Cleaning or maintenance of in place structures. All maintenance of silt fence is paid under the Administration of Erosion Management Plan Bid Item.

PART 2 – PRODUCTS

2.01. OPEN DITCH EXCAVATION

- A. Open ditch excavation includes all materials at or above the design grade plus an assumed up to 0.5 feet of over-excavation within the existing or designed channel cross-section to account for immediate sediment deposition, regardless of its nature.
- B. Rock ledges may be encountered from time to time. Contractor shall notify the engineer immediately when such is encountered. Contractor shall remove the friable rock to the extent possible using the equipment contractor intended to use to excavate earth from the open ditch.

2.02. OPEN DITCH SEEDING AND FERTILIZING

- A. Seed Mixture (Germination tests less than one year old):
 - Brome Grass 50 lb/Ac (1.15 lb/1000 SF) PLS
 - Winter Rye 1.5 Bu/Ac PLS
 - Oats 2.5 Bu/Ac PLS
- B. Pre-Seeding Fertilizer: 6-20-20 – 500 lb/Ac (11 lb/1000 SF)
- C. Post Emergence Fertilizer: Urea – 65 lb/Ac (1.5 lb/1000 SF)

2.03. OPEN DITCH SURFACE DRAIN AND TILE EXTENSION PIPES

- A. Tile Outlet and Surface Drain Pipes:
 - 1. Corrugated Metal Pipe (CMP): SUDAS 4020-201-G
 - a. Annular Corrugations Only.
 - b. Riveted Seams Only.
 - c. 16 gauge unless otherwise specified.
 - d. Use same material as pipe for all joint material and appurtenances.
 - e. 12” minimum diameter for Tile Outlets.
 - f. 15” Minimum Diameter for Surface Drains.
- B. Drain Tile Extensions to Tile Outlet Pipe:
 - 1. Reinforced Concrete Pipe (RCP): SUDAS 4020-201-A
 - a. For finished cover depths less than 8 feet, class III pipe shall be used.
 - b. For finished cover depths greater than 8 feet, class IV pipe shall be used.
 - 2. Polyvinyl Chloride Pipe (PVC): SUDAS 4020-201-E

C. Accessories:

1. Animal Guards: Agri Drain Zinc Coated Steel - Install far enough in the pipe to allow it to swivel up and let trash pass without exposing the guard beyond the pipe.
2. Flap Gate: Agri Drain Heavy Duty, 3/16" steel construction with powder coat finish, sealing collar, dual stainless steel bolt hinge.
3. Connecting Bands: 12" wide.
4. Anti-Seep Collars: Bottom half only.

2.04. REINFORCED CONCRETE PIPE TEES / ELBOWS / END CAPS / APRONS / REDUCERS / FIELD TILE CONNECTIONS

- A. Tees: Shall conform to IDOT Standard Road Plan DR-142.
- B. Elbows: Shall conform to IDOT Standard Road Plan DR-141.
- C. Endcaps: Shall conform to IDOT Standard Road Plan DR-142.
- D. Aprons: Shall conform to IDOT Standard Road Plan DR-201.
- E. Reducers: Shall conform to ASTM C76, shall have reinforcement continuous through the pipe sizes transition area and be manufactured by the concrete pipe supplier.
- F. Field Tile Connections:
 1. RCP: Conform to ASTM C76.
 2. Polyethylene: Conform to AASHTO M 252, Type C, corrugated interior and exterior or Type S corrugated exterior and smooth interior. Pipe shall be non-perforated.

2.05. STEEL SHEET PILING

- A. Sheet piling shall conform to the requirements of ASTM A328 (Steel Sheet Piling), A572 (HighStrength Low-Alloy Columbium-Vanadium Structural Steel), or A690 (High-Strength Low-Alloy steel H-Piles and Sheet Piling for Use in Marine Environments). The sheet piling provided shall meet the required cross-section, section modulus, thickness, and steel grade shown on the drawings. Fabrication of sheet piles from shorter lengths of pile stock is not permitted.

2.06. ENGINEERING FABRIC FOR UNDERLAYING RIPRAP REVEMENT

- A. Comply with Iowa DOT Article 4196.01, B (Embankment Erosion Control) and Iowa DOT Materials I.M. 490.01, Appendix G

2.07. CONCRETE GROUT FOR RIPRAP REVETMENT

A. Cement shall be Type I or Type II Portland cement conforming to ASTM C 150. Fly ash shall be in compliance with ASTM C 618, Class F or C. It may be used as a partial substitution for Portland cement for amounts not to exceed 20 percent of the total amount of cementitious material in the grout. The loss by ignition shall not exceed 4.0 percent. Fine aggregate shall conform to ASTM C 33 and shall be composed of clean, uncoated grains of material. Water shall be clean and free of harmful chemicals. Air entraining admixtures shall conform to ASTM C 260.

B. GROUT MIX:

The grout mix shall be as follows:

1. Cement: 10 sacks or 940 pounds per cubic yard.
2. Fine concrete aggregate: 2,100 pounds per cubic yard.
3. Water: 45 gallons per cubic yard or enough to provide a thick creamy consistency.
4. Air content: 6 to 10 percent.

No mixing water in excess of the amount called for in the grout mix shall be added during mixing, hauling or after arrival of the mix at the delivery point.

2.08. OPEN DITCH TEMPORARY SILT CURTAIN

A. Fabric: Comply with Iowa DOT Standard Specifications Article 4196.01.

B. Posts: 4 foot minimum steel (T-section) weighing at least 1.25 pounds per foot, exclusive of anchor plate. Painted Posts are not required. Good used posts are acceptable.

PART 3 – EXECUTION

3.01. OPEN DITCH EXCAVATION

A. Alignment:

1. Follow alignment provided which will be the approximate centerline of existing open ditch unless otherwise shown or as directed by Engineer.

B. Equipment:

1. Excavators shall be used for cleanout to minimize bank disturbance. Draglines will not be allowed without permission of engineer.
2. Other equipment, as required, to complete project.

C. Preparation:

1. Obtain Engineer's acceptance of clearing and grubbing work.
2. Construct an adequate work road where excavation will be from an existing spoil bank.

D. Excavation:

1. Includes sloping, shaping and removal of material from open ditch channel to reconstruct ditch bottom and side slopes.
2. Shape and slope ditch bottom and side slopes to reasonably conform with alignment, grade and cross sections of existing ditch bank, or flatter, or as shown on plans or as established by Engineer. All work not in conformance with this requirement shall be redone at no additional expense.
3. Unless otherwise detailed on the plans or directed or allowed by the Engineer, excavation shall commence at the downstream end of the project and proceed upstream.
4. Unless otherwise shown on the plans, excavation shall be carried out from both sides of the ditch and spoil shall be placed in approximately equal amounts on both sides of the ditch.
5. Avoid excessive over-excavation or bottom width expansion which threatens stability of ditch slopes.

E. Deposition:

1. Unless otherwise shown on the plans, spoil shall be removed uniformly from the ditch and shall be cast in piles beside the ditch as it is excavated.
2. Deposit all excavated material at least the width of the excavator tracks set back from the top of the existing ditch bank on existing ground surface unless directed or allowed otherwise by Engineer.

3. Contractor shall fill and/or shape overbank washouts to reasonably conform to the ditch cross section plan design. This is subsidiary to the work.
4. Locate spoil bank where shown on plans.

F. Work in Road/Railroad Rights-of-Way:

1. Unless otherwise provided for contractor shall apply for and secure permits to work in rights-of-way.
2. Unless otherwise detailed on the plans or as directed by the Engineer, no spoil shall be placed within public road or railroad right-of-way, except where permitted for access.
3. Contractor shall notify the appropriate road or railroad representative prior to commencing work within any right-of-way.

G. Procedures at Bridges:

1. Private Bridges (only those not scheduled for removal):
 - a. Remove and replace bridge deck to facilitate necessary excavation at contractor's option and expense.
 - b. Contractor will not be held responsible for damage to structure due to design grade line being below existing footings.
2. Private Bridges (only those scheduled for removal):
 - a. Remove bridge deck and cut pilings flush with ditch bank.
 - b. Burn and bury or otherwise dispose of all bridge materials removed.
3. County, State or Bridges or Culverts:
 - a. Remove sediment in a manner approved by Agency consistent with permit requirements.

3.02. OPEN DITCH SPOIL BANK LEVELING

A. Shaping:

1. Spoil shall be located shaped and sloped to a uniform cross section in compliance with the typical cross section shown on the plans.
2. Deep till, disk and spring tooth harrow spoil banks to depth of 8" minimum and pick up rocks and debris that surface. Perform this operation (deep till and rock / debris removal) two (2) times. Operation shall continue until all dirt clods are 4" or smaller with uniform slope and appearance from top of bank to toe of slope, subject to Engineer's approval.

3. Deep till and level all compacted areas caused by the contractor's equipment.

B. Cleanup:

1. Pick up and dispose of all boulders and rocks over 3" in diameter (fist size).
2. Dispose of all broken concrete over 3" in size.
3. Dispose of all large tree roots and other rubbish that surface during finishing operations.
4. Dispose in manner approved by Engineer.

3.03. OPEN DITCH SEEDING AND FERTILIZING

A. Equipment:

1. If a contractor chooses to perform daily seeding, the final pass of the excavator shall be with a toothed bucket to sufficiently disturb the ditch bank to more effectively hold seed.
2. If contractor chooses to do non-daily seeding and in areas where timely daily seeding has not been accomplished, a scarifier or other approved means shall be used to disturb the bank to a depth of 2 inches. An acceptable scarifier is shown on the plans.

B. Daily Seeding Method (April 1 – October 15):

1. Between April 1 and October 15, disturbed open ditch bank slopes above the normal water surface are to be fertilized and seeded with a portable cyclone seeder or by other approved means at least once each day including at the end of each day of work.
2. Fertilizer and seed shall be uniformly placed and sown as soon as practical on the fresh cut slope while the cut is still wet so that the placed material will adhere. No special preparation of areas to be seeded will be required, unless directed otherwise by Engineer.
3. Ditch bank slopes finished after October 15 are to be fertilized and seeded between the following April 1 and May 1 using the non-daily seeding method.
4. If weather prevents seeding at the end of the day, the reach shall be seeded first thing the next work day. Engineer shall determine when bank disturbance is required following a delay caused by weather. All other delays shall be assumed to trigger the requirement to seed according to the non-daily seeding method.
5. If contractor's daily seeding work is not being satisfactorily done the engineer may require that the remaining seeding be done using the non-daily seeding method for no additional compensation. Engineer may direct that poorly done areas of the seeding be redone using the non-daily seeding method and for no additional compensation.

6. After seed has germinated, contractor shall uniformly surface apply post emergence fertilizer at the specified rate.

C. Non-Daily Seeding Method (April 1 – June 1 and August 15 – October 15):

1. The contractor may opt to forego daily seed applications and instead seed long reaches of the banks of the ditch at a time. Under this option, contractor must moisten the denuded bank by applying a minimum of 0.5 gal/sf of water from the channel prior to scarifying the denuded ditch bank to a depth of 2 inches with a scarifier (or other approved means of bank disturbance) prior to applying fertilizer and seed. An acceptable scarifier is shown on the plans.
2. Engineer at Engineer's sole discretion may require up to two additional applications of water and up to two passes of the scarifier if ditch banks are not sufficiently prepared for seeding.
3. Fertilizer and seed shall be uniformly placed and sown as soon as practical on the fresh cut slope while the cut is still wet so that the placed material will adhere. No special preparation of areas to be seeded will be required, unless directed otherwise by Engineer.
4. After seed has germinated, contractor shall uniformly surface apply post emergence fertilizer at the specified rate.

3.04. OPEN DITCH SURFACE DRAIN AND TILE EXTENSION PIPES

- A. Contractor is required to maintain and provide a log of all drain tile line extension and surface drain pipes work on the open ditch. Contractor shall record the location, existing tile material, size, strength and length of materials installed, other work performed and equipment and labor time. Maintaining this log is incidental to the contract and it is to be shared with the engineer's representative during the work to better assure that it is being accurately and consistently kept. Failure to maintain an accurate log may result in Contractor being required to expose some or all of the pipe for field verification of quantities at contractor's expense.

B. Installation:

1. Complete channel excavation at the pipe location prior to commencing this work.
2. Pipes shall be in minimum lengths of twenty (20) feet unless directed or allowed otherwise by Engineer.
3. Field cutting by contractor shall be anticipated. Make all cuts for metal pipe with torch or saw. Grind rough edges.
4. Excavate and backfill as required for installation.

C. Trench, Pipe Bedding and Envelope:

1. Trench shall be not more than 24 inches wider than outside diameter of pipe.
2. The trench bottom shall be carefully shaped to closely match at least one sixth of the outside radius of the pipe.
3. Backfill shall be with on-site moist soil mechanically compacted in shallow lifts not exceeding six inches thick around and to six inches above the pipe to the satisfaction of the engineer. No density tests will be required. The remainder fill shall also be moist soil in uniformly placed and consolidated 12-inch layers to the finished ground surface.

D. Existing Drain Tile and Outlet Pipes:

1. Do not disturb existing drain tile except as necessary to extend tile and connect corrugated metal pipe outlets.
2. If given two weeks advance notice, engineer will mark all known pipe prior to excavation of the open ditch. If Contractor damages a marked pipe which was to remain un-disturbed, Contractor shall repair or replace the damaged pipe at no expense to Owner.
3. When necessary to extend or relay tile lines 12" diameter or larger, to connect to tile outlet pipe, the extension shall be made with reinforced concrete pipe of the class and size required. The RCP shall be the same or next larger standard size as is the tile being connected.
4. All smaller tile shall be extended using 10" diameter PVC as specified in the contract documents. This pipe shall be fitted over the existing tile whenever possible and be connected to the tile outlet pipe.
5. Necessary extensions or relays of existing tile less than forty feet in length may be completed when discovered, longer extensions must be first approved by Engineer.
6. Joint shall be double wrapped continuously around circumference with 12" wide geotechnical fabric. Connections of dissimilar tile shall then be encased with concrete 6" thick by 12" wide minimum.
7. Where a lateral tile line is found to be crushed, cracked and/or filled with sediment, Contractor shall notify the Engineer prior to doing additional work. Engineer will determine if replacement or abandonment is warranted.
8. Remedial tile work will not extend beyond the work limits.

E. Surface Drain Pipe:

1. Locate in low spots along open ditch or as directed by Engineer to provide drainage of surface runoff waters through finished spoil banks.

2. Camber trench bottom slightly in deeper areas in anticipation of spoil bank foundation settlement.
3. Install with the pipe inlet end 1/2 pipe diameter (not to exceed 1.0 foot) below the low grade elevation at outer spoil slope toe.
4. Install outlet with no more than two (2) feet of exposed pipe, no more than three (3) feet above the design ditch flow line (ditch bottom).
5. Provide minimum fall of one (1) foot over total pipe installation.
6. Shape spoil bank and surrounding area to drain toward inlet.
7. Install so that pipe orientation is approximately perpendicular to the open ditch centerline.
8. See plan detail.

F. Drain Tile Outlet Pipe:

1. Locate as most direct connection to open ditch, unless directed otherwise by Engineer.
2. Terminate metal pipe extension with no more than two (2) feet exposed, no more than three (3) feet above the design ditch flow line (ditch bottom).
3. Size outlet pipe to fit over drain and at least six (6) inches on undisturbed soil.
4. The pipe length shall be 20 feet and of one piece.
5. Complete connection as specified in 3.03 D for dissimilar materials.
6. Place erosion protection (rip rap) beneath pipe outlet, if directed by Engineer (Paid separately).
7. Install so that pipe orientation is approximately perpendicular to the open ditch centerline.
8. See plan detail.

G. Clean-up:

1. In anticipation of settlement, slightly mound excess trench excavation over trench.
2. Reshape spoil bank as needed.

3.05. REINFORCED CONCRETE PIPE TEES / ELBOWS / END CAPS / APRONS / REDUCERS / FIELD TILE CONNECTIONS

- A. Aprons: Tie at least the first two joints.
- B. Field Tile Connections: Comply with details and notes shown on plans.

3.06. STEEL SHEET PILING

A. Driving Sheet Pile:

1. Equipment properly sized and designed to be used to install sheetpile shall be used.
2. The piling shall be driven in a manner so as to insure perfect interlocking throughout the entire length of each pile. The piles shall be held in proper alignment during driving by means of suitable temporary guide structures which shall be removed when they have served their purpose. Piling shall be driven to the full depth shown on the drawings unless otherwise approved by the engineer.

B. Cutting Off Piles:

1. The contractor shall cut the piling off at the specified elevations. Piling length provided shall be sufficient to permit removal of all materials damaged by driving.

C. Defective Piling:

1. Unless otherwise corrected and allowed by the engineer with prior approval, any piling damaged in driving, driven out of its proper location, driven below the specified cut off elevation, or inaccurately cut off shall be pulled and replaced or re-driven. Any piling ruptured in the interlock or otherwise damaged during driving shall be pulled and replaced.

3.07. GEOTEXTILE FABRIC

A. Storage:

1. Prior to use, the geotextile shall be stored in a clean dry place, out of direct sunlight, not subject to extremes of either hot or cold, and with the manufacturer's protective cover in place. Receiving, storage, and handling at the job site shall be in accordance with the requirements in ASTM D 4873.

B. Surface Preparation:

1. The surface on which the geotextile is to be placed shall be graded to the neat lines and grades as shown on the drawings. The surface shall be firm throughout, reasonably smooth and free of loose rock and clods, holes, depressions, projections, muddy conditions and standing or flowing water (unless otherwise shown on the drawings).

C. Placement:

1. Prior to placement of the geotextile, the soil surface will be inspected for quality assurance of design and construction. The geotextile shall be placed on the approved prepared surface at the locations and in accordance with the details shown on the drawings. The geotextile shall be unrolled along the placement area and loosely laid (not stretched) in such a manner that it

will conform to the surface irregularities when material is placed on or against it. The geotextile may be folded and overlapped to permit proper placement in the designated area.

2. The geotextile shall be joined by overlapping a minimum of 18 inches (unless otherwise specified), and secured against the underlying foundation material. Securing pins, approved and provided by the geotextile manufacturer, shall be placed along the edge of the panel or roll material to adequately hold it in place during installation. Pins shall be steel or fiberglass formed as a "U", "L", or "T" shape or contain "ears" to prevent total penetration. Steel washers shall be provided on all but the "U" shaped pins. The upstream or up-slope geotextile shall overlap the abutting down-slope geotextile. At vertical laps, securing pins shall be inserted through both layers along a line through approximately the midpoint of the overlap. At horizontal laps and across slope laps, securing pins shall be inserted through the bottom layer only. Securing pins shall be placed along a line approximately 2 inches in from edge of the of the placed geotextile at intervals not to exceed 12 feet unless otherwise specified. Additional pins shall be installed as necessary and where appropriate, to prevent any undue slippage or movement of the geotextile. The use of securing pins will be held to the minimum necessary. Pins are to be left in place unless otherwise specified.
3. Should the geotextile be torn or punctured, or the overlaps disturbed, as evidenced by visible geotextile damage, subgrade pumping, intrusion, or grade distortion, the backfill around the damaged or displaced area shall be removed and restored to the original approved condition. The repair shall consist of a patch of the same type of geotextile being used, overlaying the existing geotextile. The patch shall extend a minimum of 2 feet from the edge of any damaged area.
4. The geotextile shall not be placed until it can be anchored and protected with the specified covering within 48 hours or protected from exposure to ultraviolet light. In no case shall material be dropped on uncovered geotextile from a height greater than 3 feet.

3.08. CONCRETE GROUT FOR RIRAP REVETMENT

A. Conveying and Placing:

1. Grout mix shall be delivered to the site and placed within 1 ½ hours after the introduction of the cement to the aggregates. In hot weather or under conditions contributing to quick setup of the grout mix, discharge of the concrete shall be accomplished in 45 minutes unless a set-retarding admixture is used, in which case the manufacturer's recommended time limit will apply.
2. Grout mix shall not be dropped more than 5 feet vertically unless suitable equipment is used to prevent segregation.
3. The grout mix shall not be placed until the rock riprap has been inspected and approved.
4. Rock to be grouted shall be kept wet for at least 2 hours immediately prior to grouting. Grout shall not be placed in standing or flowing water.

5. The grout shall be consolidated by heavy brooming, spading, mechanical vibration, and/or similar means. The finished surface shall be broomed to remove excess grout from exposed surfaces of the riprap. The grout shall not be forced to flow laterally to its final location.
6. The average rate of grout application shall be 3.6 cubic feet per square yard of riprap (0.4 cubic feet per square foot).

B. Curing Concrete:

Concrete shall be cured for 7 days by either:

1. Applying white pigmented curing compound at a rate of 1 gallon per 150 square feet or as recommended by the manufacturer.
2. Water soak exposed surface for the entire 7 days.
3. Cover with burlap, mats or other material and maintain in a moist condition.
4. Cover with four (4) mil plastic sheeting while concrete is still wet.

Grout mix shall not be placed when daily minimum temperatures are expected to be lower than 40 degrees F unless facilities are provided to maintain the temperature of the materials at 50 to 90 degrees F during the placement and curing period. Grout may not be placed on frozen surfaces. When freezing conditions are expected, rock shall be heated to 50 to 90 degrees F for at least 24 hours prior to placing grout.

3.09. EXPLORATORY INVESTIGATION

- A. Contractor shall use standard care in locating drains to minimize damages.
- B. Contractor shall leave holes open until engineer completes assessment of the found and exposed drains.

3.010. ADMINISTRATION OF EROSION MANAGEMENT PLAN

- A. Contractor shall comply will all stipulations of the Storm Water Erosion Management Plan.

3.011. OPEN DITCH SILT CURTAINS

- A. Close attention is warranted for the placement and maintenance of temporary open ditch silt curtains.
- B. A set of two $\frac{3}{4}$ length silt fences shall be used. The first fence should be placed extending from on bank $\frac{3}{4}$ the way across the channel to the other bank leaving a small area of unrestricted flow. The second fence should be placed approximately 5 ft. up or downstream in the same fashion with the fence beginning on the opposite bank and extending $\frac{3}{4}$ the way back across the channel.

- C. Placement of two silt fences in this manner will allow for the safe escape of fish and will act as a trap for sediments which are suspended during construction activities.
- D. The first set of silt fences / curtains shall be placed immediately downstream of where the project begins as shown on the plans.
- E. When the project has been completed $\frac{1}{2}$ way upstream, the first set of silt fences / curtains shall be carefully removed, cleaned away from the waterway and placed just downstream of where the current dredging operation is being performed.
- F. When all dredging / removal operations have been completed in the waterway, remove the second set of silt fences / curtains as described in E. above.

CONSTRUCTION PLANS FOR DRAINAGE DISTRICT NO. 57 OPEN CHANNEL CLEANOUT CERRO GORDO COUNTY, IOWA 2024

GOVERNING SPECIFICATIONS

THE 2024 EDITION OF THE "SUDAS SPECIFICATIONS FOR PUBLIC IMPROVEMENTS" SHALL GOVERN.

IOWA DEPARTMENT OF TRANSPORTATION "STANDARD SPECIFICATIONS FOR HIGHWAY AND BRIDGE CONSTRUCTION", SERIES 2015 AND ALL CURRENT GENERAL SUPPLEMENTAL SPECIFICATIONS AND MATERIALS INSTRUCTIONAL MEMORANDUM SHALL GOVERN AS REFERENCED.

ALL APPLICABLE FEDERAL, STATE, AND LOCAL LAWS AND ORDINANCES WILL BE COMPLIED WITH IN THE CONSTRUCTION OF THIS PROJECT.



NOTE: THE CONTRACTOR SHALL FIELD VERIFY EXACT LOCATIONS PRIOR TO COMMENCING CONSTRUCTION AS REQUIRED BY STATE LAW. NOTIFY IOWA ONE CALL, 811 OR 1-800-292-8989.

THE SUBSURFACE UTILITY INFORMATION IN THIS PLAN IS UTILITY QUALITY LEVEL D. THIS UTILITY QUALITY LEVEL WAS DETERMINED ACCORDING TO THE GUIDELINES OF C/ASCE 38-02, ENTITLED "STANDARD GUIDELINES FOR THE COLLECTION AND DEPICTION OF EXISTING SUBSURFACE UTILITY DATA."

UTILITY CONTACTS

THE FOLLOWING ARE KNOWN, BUT NOT NECESSARILY THE ONLY UTILITY CONTACTS THAT SHOULD BE CONTACTED PRIOR TO BEGINNING OF EXCAVATION.

ROCKWELL COOPERATIVE
TELEPHONE
Contact: David Severin
Phone: 641.822.2211
Email: rockwell@netins.net

(FCI) FRONTIER COMMUNICATIONS
Contact: Uranan Thao
Phone: 515.573.1268
Email: rontierlocatemapsia@ftr.com

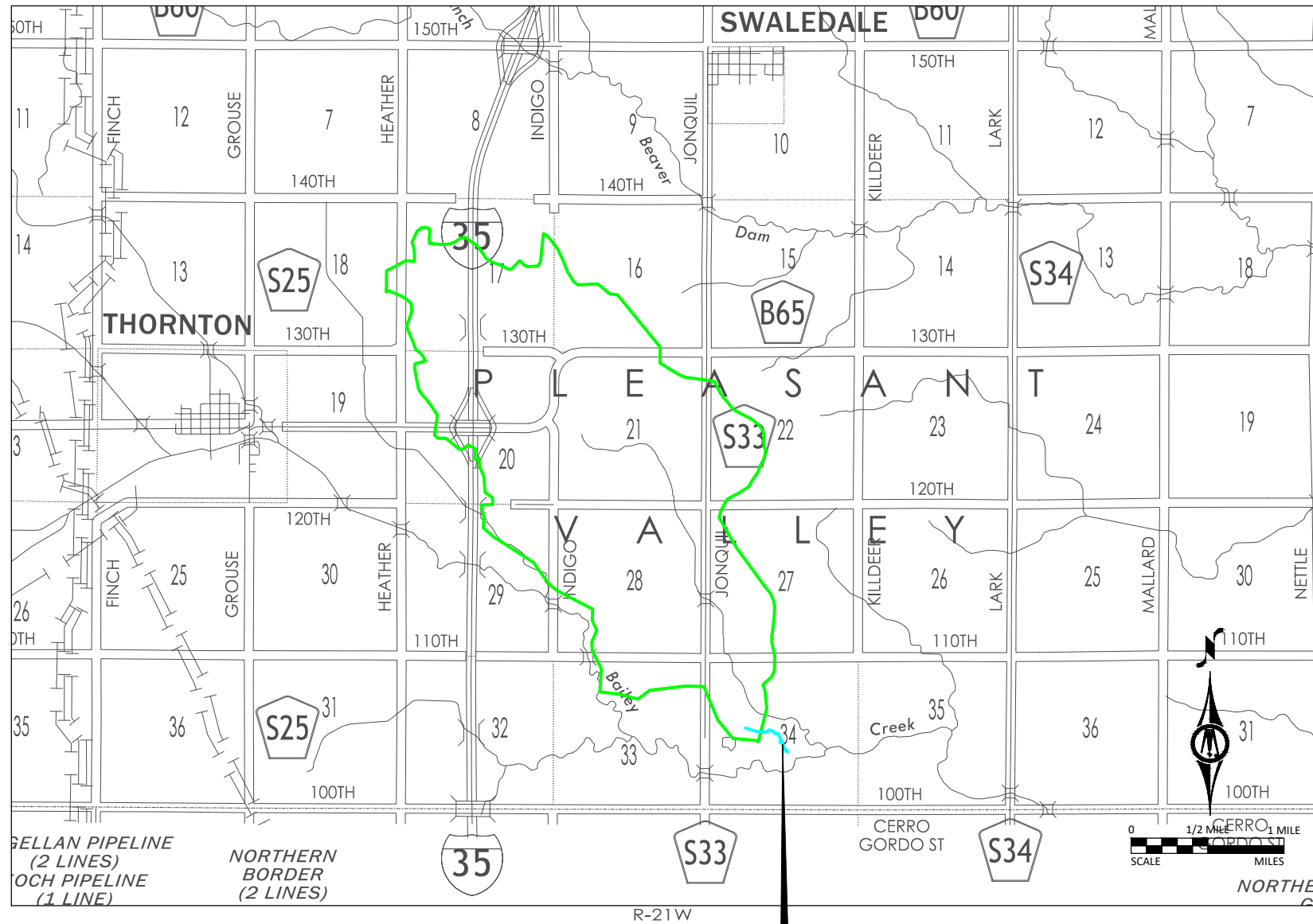

SHEET INDEX	
SHEET NO.	SHEET TITLE
A.01	TITLE SHEET
A.02	LANDOWNERS
B.01	TYPICAL OPEN DITCH DETAILS
B.02	TYPICAL RIP RAP AND OPEN DITCH BANK SHAPING DETAIL
C.01	QUANTITIES AND ESTIMATE REFERENCE
C.02	CONSTRUCTION NOTES
C.03	SEEDING AND FERTILIZING NOTES
D.01	OPEN DITCH PLAN AND PROFILE
X.01-X.05	CROSS SECTIONS

I HEREBY CERTIFY THAT THIS ENGINEERING DOCUMENT WAS PREPARED BY ME OR UNDER MY DIRECT PERSONAL SUPERVISION AND THAT I AM A DULY LICENSED PROFESSIONAL ENGINEER UNDER THE LAWS OF THE STATE OF IOWA.

Tyler A. Conley
TYLER A. CONLEY, P.E.

REG. NO. 25044 DATE: 5/6/2024

MY LICENSE RENEWAL DATE IS DECEMBER 31, 2025

PAGES OR SHEETS COVERED BY THIS SEAL:

ALL SHEETS

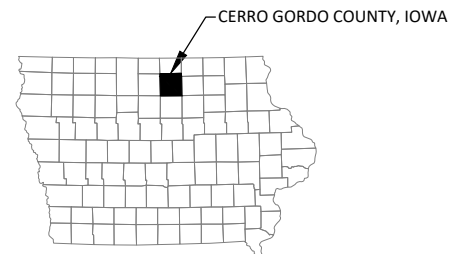

PROJECT LOCATION

PROJECT DATUM: IRCS2	RECORD DRAWING INFORMATION
HORIZONTAL: NAD83	OBSERVER:
VERTICAL: NAVD88	CONTRACTOR:
	DATE:



1609 US HWY 18 EAST
ALGONA, IOWA 50511
Phone: (515) 395-3140
Email: Algona@bolton-menk.com
www.bolton-menk.com

DESIGNED	NO.	ISSUED FOR	DATE
TAC			
DRAWN			
JKF/ALH			
CHECKED			
TAC			
CLIENT PROJ. NO.			
OP1.126016			

DRAINAGE DISTRICT NO. 57
CERRO GORDO COUNTY, IOWA
TITLE SHEET

SHEET
A.01

© Bolton & Menk, Inc. 2024. All Rights Reserved. ALGONAGA01P126016.dwg 4/29/2024 11:11:32 AM

LEGEND

- PROPOSED OPEN DITCH ALIGNMENT
- PARCEL LINES
- WATERSHED BOUNDARY



T-94-N

STA. 21+46
END CHANNEL CLEANOUT
STA. 0+00
BEGIN CHANNEL CLEANOUT

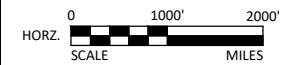

1609 US HWY 18 EAST
ALGONA, IOWA 50511
Phone: (515) 395-3140
Email: Algona@bolton-menk.com
www.bolton-menk.com

DESIGNED	NO.	ISSUED FOR	DATE
TAC			
DRAWN	JKF/ALH		
CHECKED	TAC		
CLIENT PROJ. NO.	OP1.126016		

DRAINAGE DISTRICT NO. 57
CERRO GORDO COUNTY, IOWA
LANDOWNERS

SHEET
A.02

© Bolton & Menk, Inc. 2024. All Rights Reserved. ALGONAG01A1P126016\CAD\126016.dwg 4/29/2024 11:11:43 AM

EXCAVATION AND BANK

SHAPING IS REQUIRED TO BE CARRIED OUT FROM BOTH SIDES OF THE OPEN DITCH, UNLESS OTHERWISE SPECIFIED ON PLANS. APPROXIMATELY EQUAL AMOUNTS OF SPOIL ARE TO BE PLACED ON BOTH SIDES OF THE DITCH, UNLESS OTHERWISE SPECIFIED ON PLANS.

CONTRACTOR SHALL LIMIT, AS MUCH AS PRACTICAL, DISTURBANCE OF STABLE VEGETATED BANKS WHICH LIE OUTSIDE THE DESIGN CROSS SECTION. WHERE THE DITCH IS WIDER THAN THE DESIGN CROSS SECTION, CONTRACTOR SHALL EXCAVATE AS REQUIRED TO SHAPE BOTTOM TO BASE OF SIDE SLOPES.

SPOIL BANK LEVELING

THE TOP 8 INCHES OF ALL LEVELED AND SHAPED SPOIL, OLD AND NEW, SHALL BE THOROUGHLY TILLED BY CONTRACTOR WITH A CHISEL PLOW OR SIMILAR IMPLEMENT. DISPOSE OF ROCKS AND OTHER DEBRIS EXPOSED BY THIS OPERATION. ENTIRE SOIL SURFACE SHALL BE SHAPED TO DRAIN AWAY FROM THE DITCH AND SHALL BE GENERALLY LEVEL WITH GENTLE UNDULATIONS ON A LINE PARALLEL TO DITCH. CHISELING AND FINISH GRADING ARE INCIDENTAL TO THE SPOIL BANK LEVELING BID ITEM.

MINOR SURFACE GRADING TO DRAIN SMALL IMPOUNDED AREAS AND THE CONSTRUCTION OF TEMPORARY FIELD ENTRANCES OR SURFACE WATER CONTROL DIKES IN THE PUBLIC ROAD DITCHES ARE INCIDENTAL TO THE SPOIL BANK LEVELING BID ITEM.

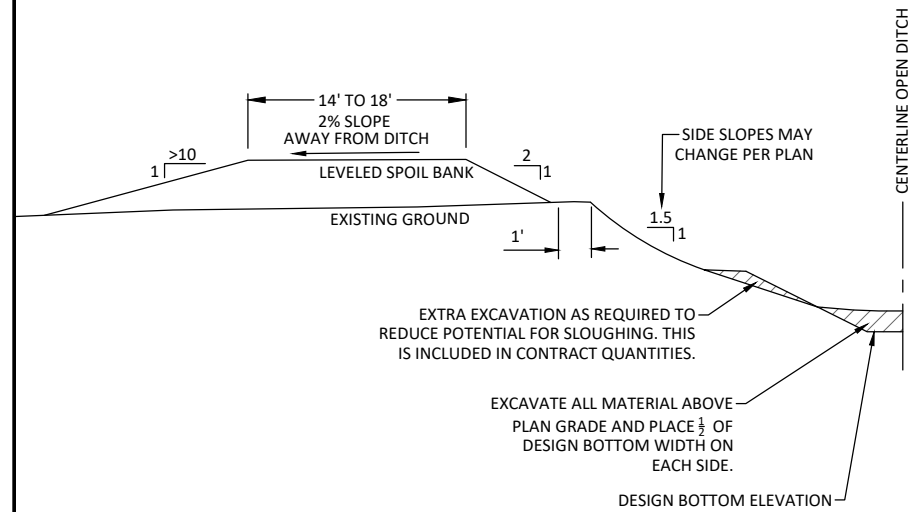

TYPICAL OPEN DITCH EXCAVATION & SPOIL LEVELING

WHERE IT IS NECESSARY TO EXTEND OR RELAY TILE LINES. 12" OR LARGER IN DIAMETER TO REACH TILE EXTENSION PIPES, THE EXTENSION SHALL BE WITH CONCRETE OR SITE-SALVAGED DRAIN TILE SECTIONS IN A TRENCH WITH A MAXIMUM WIDTH 12" WIDER THAN THE TILE SECTIONS. USE NEW CLASS III CONCRETE DRAIN TILE WITH CLASS R-2 BEDDING. EXTEND ALL SMALLER TILE LINES WITH 10" DIAMETER SDR-35 PVC SEWER PIPE FITTED OVER TILE AND INTO OUTLET PIPE. NECESSARY EXTENSIONS OR RELAYS LESS THAN 10 FEET IN LENGTH MAY BE COMPLETED WHEN DISCOVERED. LONGER EXTENSIONS MUST BE FIRST APPROVED BY ENGINEER. CORRUGATED PLASTIC DRAIN TILE IS NOT PERMITTED.

WHEN A TILE LINE IS FOUND TO BE CRUSHED, CRACKED, OR FILLED WITH SEDIMENT, CONTRACTOR IS TO NOTIFY ENGINEER PRIOR TO DOING ADDITIONAL WORK. ENGINEER WILL DETERMINE IF REPLACEMENT OR ABANDONMENT IS WARRANTED. TILE REPLACEMENT WILL NOT EXTEND BEYOND THE WORK LIMITS.

CONTRACTOR IS REQUIRED TO MAINTAIN AND PROVIDE A LOG OF ALL DRAIN TILE LINE EXTENSION AND REPLACEMENT WORK RECORDING LOCATION, EXISTING TILE MATERIAL, SIZE, STRENGTH & LENGTH OF MATERIALS INSTALLED, OTHER WORK PERFORMED AND MACHINE AND LABOR TIME. LOG KEEPING IS SUBSIDIARY TO THE CONTRACT. FAILURE TO MAINTAIN AN ACCURATE LOG WILL RESULT IN CONTRACTOR HAVING TO UNCOVER HIS WORK FOR VERIFICATION AT HIS COST.

ALL CONNECTIONS OF DRAIN TILE TO EXTENSION PIPES OR TO SDR-35 PVC SEWER PIPES ARE TO BE ENCASED IN A PORTLAND CEMENT CONCRETE COLLAR AT LEAST 12" WIDE AND 6" THICK CONTINUOUS AROUND THE JOINT. THIS WORK IS INCIDENTAL TO THE DRAIN TILE EXTENSION PIPE BID ITEMS.

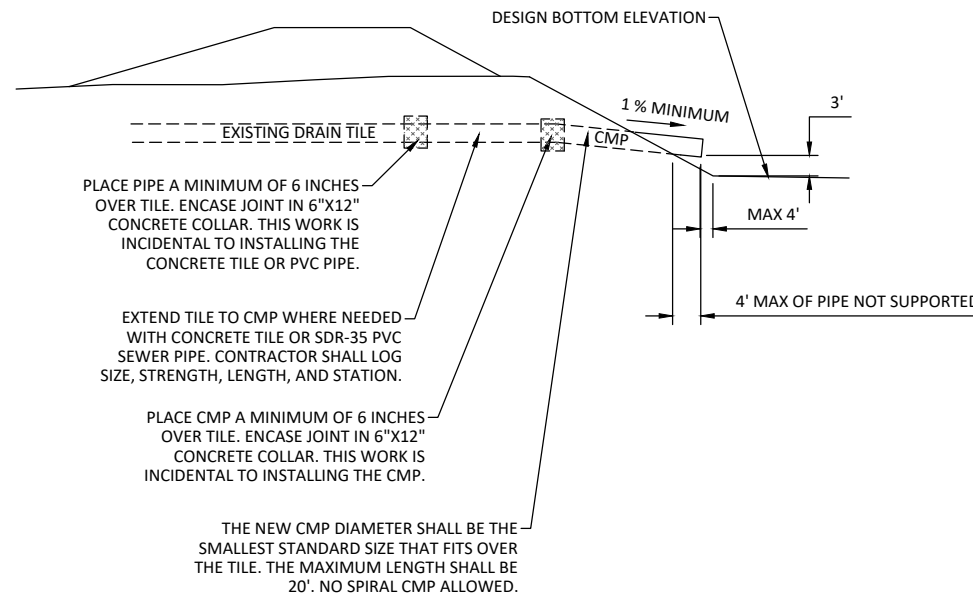

TYPICAL TILE EXTENSION INSTALLATION

STANDARD PIPE WORK ABBREVIATIONS

- UAC = USE AS CONSTRUCTED
- TE = TILE EXTENSION
- AG = ANIMAL GUARD
- FG = FLOOD GATE
- RS&R = REMOVE, SALVAGE, & REINSTALL
- SD = SURFACE DRAIN
- CMP = CORRUGATED METAL PIPE
- RCP = REINFORCED CONCRETE PIPE

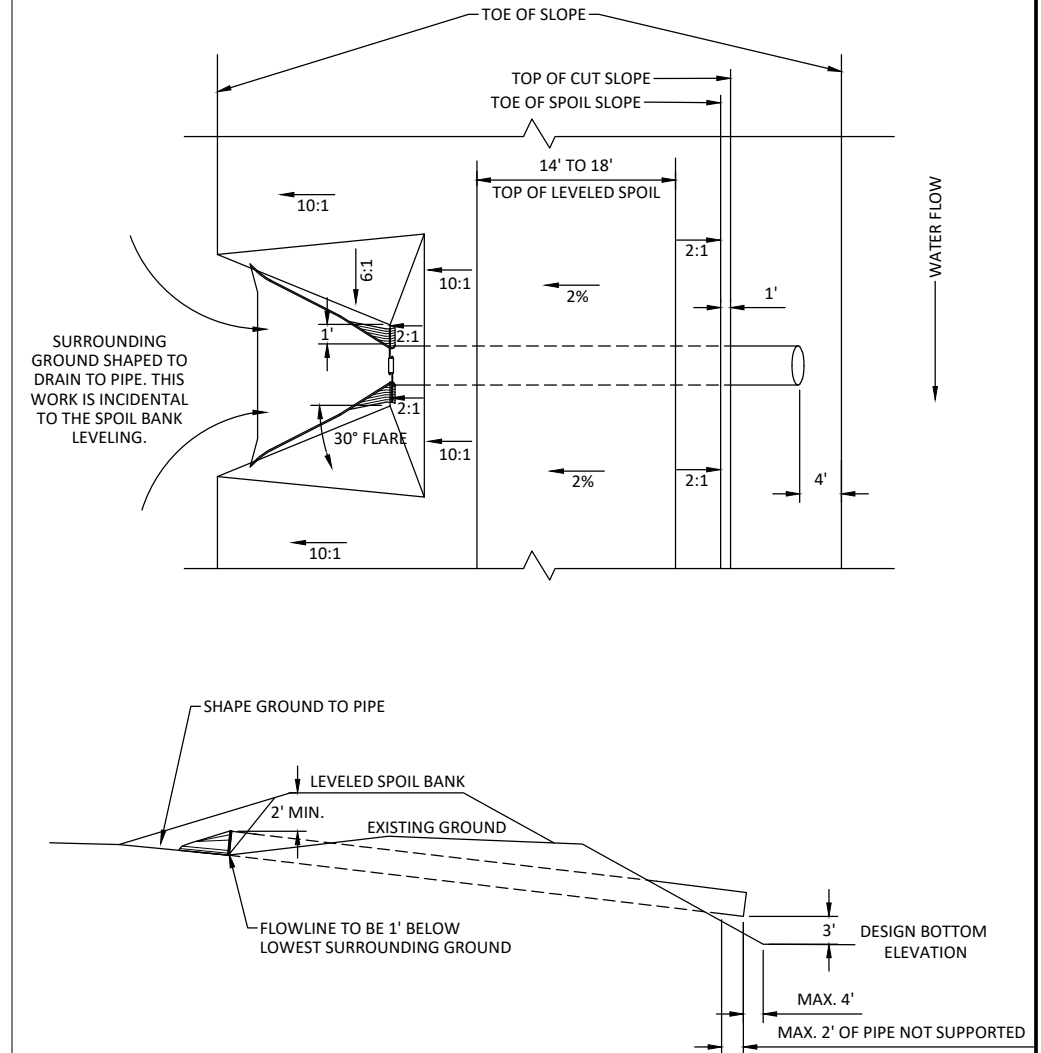

TYPICAL SURFACE DRAIN INSTALLATION

© Bolton & Menk, Inc. 2024. All Rights Reserved. ALGONOA\DW\126016\CAD\126016.dwg 4/29/2024 11:11:53 AM



1609 US HWY 18 EAST
ALGONA, IOWA 50511
Phone: (515) 395-3140
Email: Algona@bolton-menk.com
www.bolton-menk.com

DESIGNED	NO.	ISSUED FOR	DATE
TAC			
DRAWN			
JKF/ALH			
CHECKED			
TAC			
CLIENT PROJ. NO.			
OP1.126016			

DRAINAGE DISTRICT NO. 57

CERRO GORDO COUNTY, IOWA

TYPICAL OPEN DITCH DETAILS

SHEET

B.01

RIPRAP

ENGINEER WILL MARK THE BEGINNING AND THE END OF ALL REACHES WHERE RIPRAP WILL BE PLACED. DESIGN PROVIDES THAT NONE OF THE RIPRAP OR FILL WILL ENCROACH ON THE PRE-DISASTER CROSS SECTION OR THE HISTORIC DESIGN CROSS SECTION SLOPE. THE BOTTOM OF THE RIPRAP MUST BE PLACED ON TILL OR A MINIMUM OF ONE FOOT BELOW EXISTING LOWEST FLOW CHANNEL. HEIGHT OF RIPRAP IS FIVE TO SIX FEET WHERE ONE TON IS PLACED PER LINEAL FOOT OF DITCH. THIS BID ITEM SHALL BE PAID BY THE TON. BANK SHAPING IS INCLUDED IN THIS ITEM.

CONTRACTOR MUST SUPPLY ROCK TICKETS FOR EACH SITE WITH THE SITE NUMBER HAND WRITTEN ON EACH TICKET. CONTRACTOR SHALL PROVIDE AND PLACE 95% OF PLANNED RIPRAP REVETMENT BUT NOT OVER 105% PER SITE. ANY RIPRAP INSTALLED OVER 105% SHALL BE CONSIDERED DONE AT CONTRACTOR'S EXPENSE AND WILL NOT BE PAID FOR BY THE DRAINAGE DISTRICT.

SOURCE OF FILL BEHIND RIPRAP SHALL BE FROM ON SITE SPOIL BANKS TAKE SHALLOW LIFTS FROM THE SPOIL BANK ON THE SAME SIDE OF THE OPEN DITCH AND WITHIN 300 FEET OF THE RIPRAP AREA. RESHAPE SPOIL PILE SURFACE. THIS WORK IS INCIDENTAL TO THIS BID ITEM. SPOIL THAT IS PLACED ON TOP OF BANK BECAUSE OF THIS OPERATION, SHALL TO BE SHAPED TO BE DRAINED AND FARMABLE. IT SHALL NOT BE PLACED TO FUNCTION AS A LEVEE. THIS WORK IS INCIDENTAL TO THIS BID ITEM. CONTRACTOR SHALL DISPOSE OF ALL ROCKS AND OTHER DEBRIS EXPOSED BY THIS OPERATION. THIS WORK IS INCIDENTAL TO THIS BID ITEM.

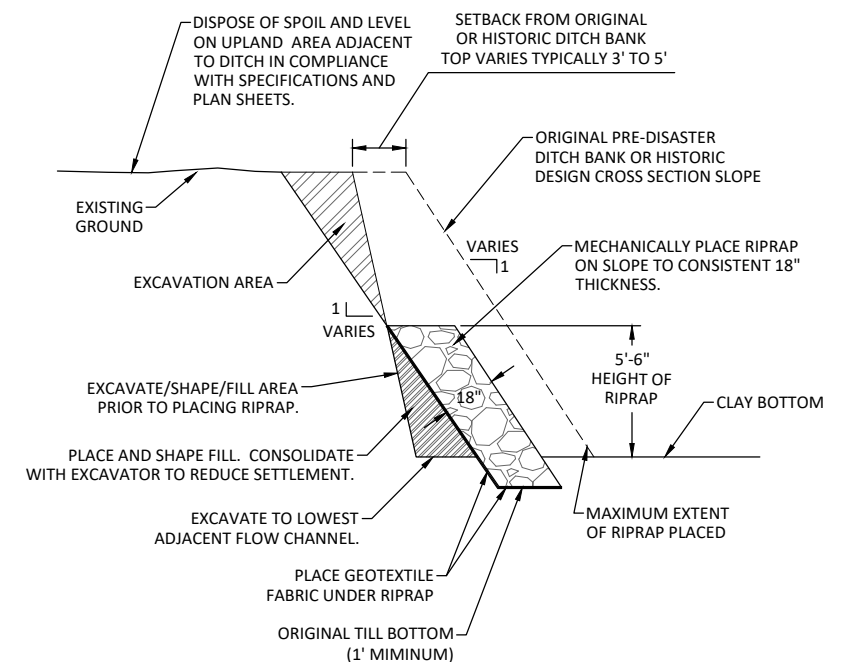

TYPICAL RIP RAP AND OPEN DITCH BANK SHAPING

ESTIMATED PROJECT QUANTITIES				
OPEN CHANNEL CLEANOUT				
ITEM NO.	ITEM CODE	ITEM DESCRIPTION	UNIT	TOTAL
1	BMIDD-107-A-0	OPEN DITCH EXCAVATION	STA	21.5
2	BMIDD-107-B-0	SPOIL BANK LEVELING (TWO SIDES)	STA	17
3	BMIDD-107-B-0	SPOIL BANK LEVELING (ONE SIDE)	STA	3.25
4	BMIDD-107-C-0	SEEDING AND FERTILIZING OPEN DITCH	STA	21.5
5	BMIDD-107-D-0	CMP SURFACE DRAIN, 24" DIA.	LF	40
6	BMIDD-107-D-0	CMP SURFACE DRAIN APRON, 24" DIA.	EA	1
7	BMIDD-107-D-0	CMP TILE EXTENSION, 12" DIA.	LF	20
8	BMIDD-107-D-0	ANIMAL GUARDS, 12" DIA.	EA	1
9	BMIDD-107-G-0	GEOTEXTILE FABRIC	SY	25
10	2010-108-C-0	CLEARING AND GRUBBING	LS	1
11	9040-108-J-0	RIPRAP, IDOT CLASS E	TN	25
12	9060-108-E-0	FENCE CUTS	EA	1
13	9060-108-E-0	REMOVAL OF FENCE, FIELD	LF	100
14	11020-108-A-0	MOBILIZATION	LS	1

ESTIMATE REFERENCE INFORMATION		
OPEN CHANNEL CLEANOUT		
ITEM NO.	ITEM CODE	ITEM DESCRIPTION
1	BMIDD-107-A-0	OPEN DITCH EXCAVATION QUANTITY INCLUDES ADDITIONAL 5% FOR 0.5' OVER-EXCAVATION OF DITCH BOTTOM.
2	BMIDD-107-B-0	SPOIL BANK LEVELING (TWO SIDES)
3	BMIDD-107-B-0	SPOIL BANK LEVELING (ONE SIDE)
4	BMIDD-107-C-0	SEEDING AND FERTILIZING OPEN DITCH FOR AREAS WITHIN TOP OF BANK ONLY. SEE SEEDING AND FERTILIZING NOTES.
5	BMIDD-107-D-0	CMP SURFACE DRAIN, 24" DIA.
6	BMIDD-107-D-0	CMP SURFACE DRAIN APRON, 24" DIA.
7	BMIDD-107-D-0	CMP TILE EXTENSION, 12" DIA. ITEM INCLUDES UP TO 20 LF OF TILE TO CONNECT EXISTING TILE TO CMP EXTENSION. INCLUDES SALVAGING AND REINSTALLATION OF ANY EXISTING ANIMAL GUARDS WHERE SIZE PERMITS.
8	BMIDD-107-D-0	ANIMAL GUARDS, 12" DIA. ITEM IS FOR THOSE LOCATIONS WHERE AN ANIMAL GUARD EXISTS BUT CANNOT BE RE-USED. INCLUDES FURNISHING AND INSTALLATION.
9	BMIDD-107-G-0	GEOTEXTILE FABRIC SEE SHEET (RIPRAP DETAIL SHEET)
10	2010-108-C-0	CLEARING AND GRUBBING
11	9040-108-J-0	RIPRAP, IDOT CLASS E WEIGH TICKETS REQUIRED
12	9060-108-E-0	FENCE CUTS SEE CONSTRUCTION NOTES. ASSUMES APPROX. 50 LF AT EACH CROSSING.
13	9060-108-E-0	REMOVAL OF FENCE, FIELD
14	11020-108-A-0	MOBILIZATION

© Bolton & Menk, Inc. 2024. All Rights Reserved
A:\GENCO\A\OP1126016\CAD\CAD126016.dwg 4/29/2024 11:11:54 AM



1609 US HWY 18 EAST
ALGONA, IOWA 50511
Phone: (515) 395-3140
Email: Algona@bolton-menk.com
www.bolton-menk.com

DESIGNED	NO.	ISSUED FOR	DATE
TAC			
DRAWN			
JKF/ALH			
CHECKED			
TAC			
CLIENT PROJ. NO.			
OP1-126016			

DRAINAGE DISTRICT NO. 57
CERRO GORDO COUNTY, IOWA
QUANTITIES AND ESTIMATE REFERENCE

SHEET
C.01

CONSTRUCTION NOTES - OPEN DITCH

PLAN NOTES SUPERSEDE CONFLICTING PROVISIONS IN THE TECHNICAL SPECIFICATIONS.

- 1. WORK LIMITS.** ARE GENERALLY 100 FEET FROM THE CENTERLINE OF THE DITCH, OR AS OTHERWISE SHOWN ON THE PLANS. THE WORK AREA MAY BE EXPANDED IF NECESSARY TO COMPLETE THE WORK WITH THE PRIOR APPROVAL OF ENGINEER.
- 2. EXCAVATION AND BANK SHAPING** IS REQUIRED TO BE CARRIED OUT FROM BOTH SIDES OF THE OPEN DITCH UNLESS OTHERWISE NOTED OR APPROVED BY ENGINEER. APPROXIMATELY EQUAL AMOUNTS OF SPOIL ARE TO BE PLACED ON EACH SIDE OF THE DITCH UNLESS OTHERWISE SPECIFIED ON PLANS. A MACHINE WITH THE NECESSARY REACH TO ACCOMPLISH THE CLEANOUT WITHOUT DISTURBING THE TOP EXISTING BANK WILL BE REQUIRED. CONTRACTOR SHALL LIMIT, AS MUCH AS PRACTICAL, DISTURBANCE OF STABLE VEGETATED BANKS WHICH LIE OUTSIDE THE DESIGN CROSS SECTION. WHERE THE DITCH IS WIDER THAN THE DESIGN CROSS SECTION, CONTRACTOR SHALL EXCAVATE AS REQUIRED TO SHAPE BOTTOM TO BASE OF SIDE SLOPES.
- 3. NEW PIPE**
 - ALL NEW PIPES ARE TO BE FABRICATED FROM CORRUGATED STEEL OR IRON.
 - ALL NEW PIPES ARE TO HAVE ANNULAR CORRUGATION AND RIVETED OR RESISTANCE SPOT WELDED SEAMS.
 - MINIMUM TILE PIPE SIZE IS 12". SUBSTITUTE NEW 12" FOR ALL SMALLER TILE INSTALLATIONS MARKED "INSTALL;" OR "REMOVE, SALVAGE AND REINSTALL".
- 4. DRAIN TILE LINES.** WHERE IT IS NECESSARY TO EXTEND OR RELAY TILE LINES, 12" DIA. OR LARGER, TO CONNECT TO TILE EXTENSION PIPES THE EXTENSION SHALL BE WITH REINFORCED CONCRETE PIPE IN A TRENCH WITH A MAXIMUM WIDTH 24" WIDER THAN THE PIPE SECTIONS, THE PIPE SHALL BE INSTALLED IN COMPLIANCE WITH PLANS AND SPECIFICATIONS. USE CLASS III RCP WHEN COVER DEPTH DOES NOT EXCEED 8 FEET. USE CLASS IV RCP WHEN COVER DEPTH EXCEEDS 8 FEET. DUAL WALL HDPE N-12 PIPE MAY BE USED ONLY WITH THE ENGINEER'S APPROVAL, WHICH MAY BE WITHHELD AT ENGINEER'S SOLE DISCRETION IF IT IS NOT BEING INSTALLED AS SPECIFIED. EXTEND ALL SMALLER TILE LINES WITH 10" DIAMETER PVC SDR-35 SEWER PIPE FITTED OVER TILE WHENEVER POSSIBLE AND INTO OUTLET PIPE. NECESSARY EXTENSIONS OR RELAYS LESS THAN 20 FEET IN LENGTH MAY BE COMPLETED WHEN DISCOVERED. LONGER EXTENSIONS MUST BE FIRST APPROVED BY ENGINEER. THIS WORK SHALL BE PAID AT THE UNIT PRICE BID FOR PIPE CULVERT TILE EXTENSION, FOR THE APPLICABLE DIAMETER PIPE FOR THE ACTUAL LENGTH OF TILE LINE INSTALLED. PIPE BEDDING SHALL BE INCIDENTAL TO EXTENDING THE TILE LINES AND WILL NOT BE PAID FOR SEPARATELY.

WHERE A LATERAL TILE LINE IS FOUND TO BE CRUSHED, CRACKED AND/OR FILLED WITH SEDIMENT CONTRACTOR SHALL NOTIFY THE ENGINEER PRIOR TO DOING ADDITIONAL WORK. ENGINEER WILL DETERMINE IF REPLACEMENT OR ABANDONMENT IS WARRANTED. TILE REPLACEMENT WILL NOT EXTEND BEYOND THE WORK LIMITS.

CONTRACTOR IS REQUIRED TO MAINTAIN AND PROVIDE A LOG OF ALL DRAIN TILE LINE EXTENSION AND REPLACEMENT WORK. CONTRACTOR SHALL RECORD THE LOCATION, EXISTING TILE MATERIAL, SIZE, STRENGTH & LENGTH OF MATERIALS INSTALLED, OTHER WORK PERFORMED, AND EQUIPMENT AND LABOR TIME. MAINTAINING THIS LOG IS INCIDENTAL TO THE CONTRACT. FAILURE TO MAINTAIN AN ACCURATE LOG WILL RESULT IN CONTRACTOR BEING REQUIRED TO EXPOSE THE PIPE FOR FIELD VERIFICATION OF QUANTITIES AT CONTRACTOR'S EXPENSE.

ALL CONNECTIONS OF DRAIN TILE TO EXTENSION PIPES ARE TO BE ENCASED IN A PORTLAND CEMENT CONCRETE COLLAR AT LEAST 12" WIDE AND 6" THICK CONTINUOUS AROUND THE JOINT. THIS WORK SHALL BE CONSIDERED INCIDENTAL TO THE TILE EXTENSION BID ITEM AND WILL NOT BE PAID FOR SEPARATELY.

- 5. ANIMAL GUARDS.** IF AN ANIMAL GUARD EXISTS IN AN EXISTING TILE EXTENSION AND THE TILE EXTENSION IS BEING REPLACED, THE ANIMAL GUARD SHALL BE REPLACED WITH A NEW ANIMAL GUARD OF THE PROPER SIZE.
- 6. RIPRAP.** PLACEMENT LOCATIONS WILL BE MARKED DURING CONSTRUCTION. LENGTH, HEIGHT & THICKNESS OR TONS PER FOOT AND CLASS OF ROCK WILL BE SPECIFIED. UNLESS OTHERWISE NOTED, FOR OPEN DITCH BANK STABILIZATION USE CLASS E RIPRAP AT ONE TON PER FOOT ON BOTTOM 5 FEET OF DITCH BANK SLOPE. ENGINEERING FABRIC NOT REQUIRED UNLESS OTHERWISE SPECIFIED, ENGINEERING FABRIC WILL BE PAID UNDER SEPARATE BID ITEM.
- 7. SPOIL BANK LEVELING.** SPOIL PILES ARE TO BE PLACED, LEVELED, SHAPED AND GRADED IN COMPLIANCE WITH PLAN REQUIREMENTS AND SUPPLEMENTAL SPECIFICATIONS. SEE PLAN SHEET D.01. THE TOP 8 INCHES OF ALL LEVELED SPOIL, OLD AND NEW, IS TO BE TILLED BY CONTRACTOR WITH A CHISEL PLOW OR OTHER APPROVED IMPLEMENT. DISPOSE OF ROCKS (FIST SIZE OR LARGER) AND OTHER DEBRIS EXPOSED BY THIS OPERATION. CHISELING AND FINISH GRADING ARE SUBSIDIARY TO THE SPOIL BANK LEVELING BID ITEM.
- 8. PIPE WORK IN OPEN DITCH.** QUANTITIES FOR THE OPEN DITCH WORK ARE ONLY AN ESTIMATE BASED ON PRELIMINARY SURVEY INFORMATION. MOST PIPE WORK LOCATIONS ARE SHOWN ON THE PLANS BUT THESE MAY CHANGE AND THERE MAY BE NEW PIPE WORK LOCATIONS ADDED DURING THE COURSE OF THE PROJECT. WORK TO BE DONE AT EACH LOCATION WILL BE DETERMINED IN THE FIELD. CONTRACTOR'S MOVEMENTS BETWEEN THE SEVERAL MARKED PIPE WORK SITES AND ANY ADDED SITES ON THE ENTIRE DITCH DURING THE ENTIRE CONTRACT PERIOD IS CONSIDERED INCIDENTAL TO THE APPLICABLE PIPE WORK BID ITEM.
- 9. BRIDGES AND CULVERTS.** ARE TO BE COMPLETELY CLEAR OF SEDIMENT ABOVE THE PLAN SECTION AT THE TIME ENGINEER MAKES THE FINAL INSPECTION. THIS WORK IS INCIDENTAL TO THE EXCAVATION BID ITEM.

COMMON ABBREVIATIONS USED IN PLANS AND SPECIFICATIONS:

- RCP - REINFORCED CONCRETE PIPE
- CMP - CORRUGATED METAL PIPE
- HDPE - HIGH DENSITY POLYETHYLENE PIPE (DUAL WALL PLASTIC)
- CPDT - CORRUGATED POLYETHYLENE DRAINAGE TUBING (SINGLE WALL PLASTIC)
- DIA. - DIAMETER
- N - NORTHING
- E - EASTING
- EL. OR ELEV. - ELEVATION
- BM - BENCHMARK
- ROW - RIGHT OF WAY
- NO. - NUMBER
- IDOT - IOWA DEPARTMENT OF TRANSPORTATION
- DR-X - CURRENT IDOT STANDARD ROAD PLAN OR DETAIL
- RS&R - REMOVE SALVAGE AND RELAY
- F&I - FURNISH AND INSTALL
- SD - SURFACE DRAIN
- TE - TILE EXTENSION
- UAC - USE AS CONSTRUCTED

© Bolton & Menk, Inc. 2024. All Rights Reserved. A:\GEN001A\01126016\01126016.dwg 4/29/2024 11:11:55 AM



1609 US HWY 18 EAST
ALGONA, IOWA 50511
Phone: (515) 395-3140
Email: Algona@bolton-menk.com
www.bolton-menk.com

DESIGNED	NO.	ISSUED FOR	DATE
TAC			
DRAWN			
JKF/ALH			
CHECKED			
TAC			
CLIENT PROJ. NO.			
OP1.126016			

DRAINAGE DISTRICT NO. 57

CERRO GORDO COUNTY, IOWA

CONSTRUCTION NOTES

SHEET

C.02

CONSTRUCTION NOTES - FOR OPEN DITCH SEEDING AND FERTILIZING

PLAN NOTES SUPERSEDE CONFLICTING PROVISIONS IN THE TECHNICAL SPECIFICATIONS.

1. MEASUREMENT AND PAYMENT.

- A. MEASUREMENT:** MEASURE AT 100 FOOT STATIONS ALONG CENTERLINE OF DITCH.
- B. PAYMENT:** UNIT PRICE PER 100 FOOT STATIONS SHALL BE FULL COMPENSATION FOR SEEDING AND FERTILIZING DISTURBED BANKS AT THE RATES SPECIFIED IN THE CONTRACT DOCUMENTS.
- C. INCLUDES:** SUPPLYING SEED SACKS AND TAGS AND FERTILIZER TAGS OR OTHER EVIDENCE OF COMPLIANCE WITH THE SPECS TO THE ENGINEER. ALL REQUIRED SEED TREATMENTS, ANY NECESSARY SEED BED PREPARATION, LABOR, EQUIPMENT, TOOLS, AND MISCELLANEOUS ASSOCIATED WORK NECESSARY TO COMPLETE ITEM ON ONE SIDE OR BOTH SIDES RESPECTIVELY AS SPECIFIED.

2. SEED MIXTURE.

- BROME GRASS 50 LB/AC (1.15 LB/1000 SF) PLS
- WINTER RYE 84 LB/AC (1.95 LB/1000 SF) PLS
- OATS 80 LB/AC PLS (1.85 LB/1000 SF) PLS

SEED SHALL BE TREATED WITH STICKING AGENT, INOCULANT, AND FUNGICIDE WHEN APPROPRIATE.

3. FERTILIZER. USE FERTILIZER OF THE GRADE, TYPE, AND FORM SPECIFIED THAT COMPLIES WITH RULES OF THE IOWA DEPARTMENT OF AGRICULTURE AN LAND STEWARDSHIP AND THE FOLLOWING REQUIREMENTS:

- A. GRADE:** IDENTIFY THE GRADE OF FERTILIZER ACCORDING TO THE PERCENT NITROGEN (N), PERCENT OF AVAILABLE PHOSPHORIC ACID (P₂O₅), AND PERCENT WATER SOLUBLE POTASSIUM (K₂O), IN THAT ORDER, AND BASE APPROVAL ON THAT IDENTIFICATION.
THE CONTRACTOR MAY SUBSTITUTE OTHER FERTILIZER CONTAINING ANALYSIS PERCENTAGES DIFFERENT FROM THOSE SPECIFIED, PROVIDED THAT THE MINIMUM AMOUNTS OF ACTUAL NITROGEN, PHOSPHATE, AND POTASH PER ACRE ARE SUPPLIED, AND THAT IN NO CASE DOES THE TOTAL AMOUNT PER ACRE OF THE THREE FERTILIZER ELEMENTS BE EXCEEDED BY 30% OF THE FOLLIWING MINIMUM AMOUNTS.
- B. TYPE:** USE FERTILIZER THAT CAN BE UNIFORMLY DISTRIBUTED BY THE APPLICATION EQUIPMENT. FURNISH FERTILIZER EITHER AS SEPARATE INGREDIENTS OR IN CHEMICALLY-COMBINED FORM.
PRE-SEEDING FERTILIZER: 6-20-20 - 500 LB/AC (11 LB/1000 SF)
POST EMERGENCE FERTILIZER: 48-0-0 (UREA) - 65 LB/AC (1.5 LB/1000 SF)

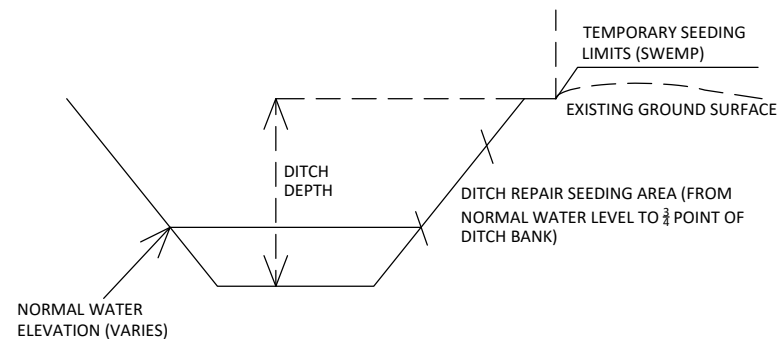

AREA OF SEEDING FOR DEPTH OF DITCH AND PORTION OF VEGETATION REMOVED (SF PER STATION PER SIDE) FOR SIDESLOPE 1.5:1

DITCH DEPTH (FT)	1/2 BANK	3/4 BANK	FULL BANK
6	270	541	811
8	451	811	1172
10	631	1082	1532
12	811	1352	1893
14	992	1622	2253
16	1172	1893	2614
18	1352	2163	2975

AREA OF SEEDING FOR DEPTH OF DITCH AND PORTION OF VEGETATION REMOVED (SF PER STATION PER SIDE) FOR SIDESLOPE 2:1

DITCH DEPTH (FT)	1/2 BANK	3/4 BANK	FULL BANK
6	335	671	1006
8	559	1006	1453
10	783	1342	1901
12	1006	1677	2348
14	1230	2012	2795
16	1453	2348	3242
18	1677	2683	3690

4. DAILY SEEDING. BETWEEN APRIL 1 AND OCTOBER 15, DISTURBED OPEN DITCH BANK SLOPES ABOVE THE NORMAL WATER SURFACE ARE TO BE FERTILIZED AND SEEDED WITH A PORTABLE CYCLONE SEEDER OR BY OTHER APPROVED MEANS AT LEAST ONCE (MINIMUM) AT THE END OF EACH DAY OF WORK.

FERTILIZER AND SEED SHALL BE PLACED AND SOWN AS SOON AS PRACTICAL ON THE FRESH CUT SLOPE WHILE THE CUT IS STILL WET AND ALL PLACED MATERIAL WILL ADHERE. NO SPECIAL PREPARATION OF AREAS TO BE SEEDDED WILL BE REQUIRED, UNLESS OTHERWISE DIRECTED BY THE ENGINEER.

DITCH BANK SLOPES FINISHED AFTER OCTOBER 15 ARE TO BE FERTILIZED AND SEEDDED BETWEEN APRIL 1 AND APRIL 20.

AFTER SEED HAS GERMINATED, CONTRACTOR SHALL APPLY POST EMERGENCE FERTILIZER AT THE SPECIFIED RATE.

5. NON-DAILY SEEDING.THE CONTRACTOR MAY OPT TO FOREGO DAILY SEED APPLICATIONS AND INSTEAD SEED LONG REACHES OF THE DITCH AT A TIME. UNDER THIS OPTION, CONTRACTOR MUST WET AND DISTURB TO A DEPTH OF 2 INCHES THE DENUDED DITCH BANK WITH A BOBCAT SCARIFIER (OR OTHER APPROVED MEANS OF BANK DISTURBANCE) PRIOR TO APPLYING FERTILIZER AND SEED.

ENGINEER AT ENGINEER'S SOLE DISCRETION MAY REQUIRE UP TO TWO ADDITIONAL PASSES IF DITCH BANKS ARE NOT SUFFICIENTLY DISTURBED.

AFTER SEED HAS GERMINATED, CONTRACTOR SHALL APPLY POST EMERGENCE FERTILIZER AT THE SPECIFIED RATE.

MOUNT DISTURBANCE IMPLEMENT ON APPROPRIATE EQUIPMENT OR SKID TO PROTECT DITCH BANK FROM DAMAGE.

6. ACCEPTABLE DISTURBANCE METHODS/EQUIPMENT.

6.1. DAILY SEEDING: FINAL PASS OF EXCAVATOR SHALL BE WITH A TOOTHED BUCKET TO SUFFICIENTLY DISTURB THE DITCH BANK TO MORE EFFECTIVELY HOLD SEED.

6.2. NON-DAILY SEEDING: IF CONTRACTOR CHOOSES TO SEED LONG REACHES, A BOBCAT SCARIFIER SHALL BE USED TO DISTURB THE BANK TO A DEPTH OF 2 INCHES.

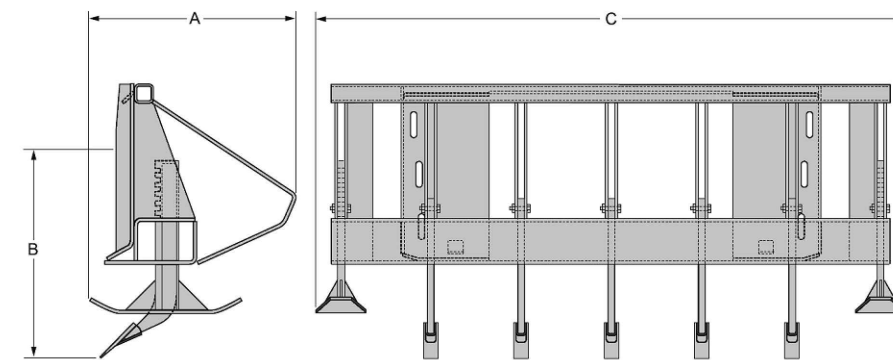

Main features

- Scarifier includes two depth guides and five teeth.
- Adjustable depth skids for presetting digging depth.
- Prepares hard-pack ground for digging or landscaping.
- Standard five-tooth unit with additional teeth available.
- Bob-Tach™ mounted for easy attachment changes.
- Rips light asphalt for removal.



Item number
Scarifier 6563526

Weights and dimensions

	Operating weight	Shipping weight	Overall Width (C)	Overall Height (B)	Overall length (A)
Scarifier	350 lbs	350 lbs	60 in.	26 in.	24 in.

Characteristics and performance

	Number of Teeth	Maximum Dig Depth (approximate)
Scarifier	5	6 in.

© Bolton & Menk, Inc. 2024. All Rights Reserved. ALGONOA\PI\126016\CD\126016.dwg 4/29/2024 11:11:55 AM



1609 US HWY 18 EAST
ALGONA, IOWA 50511
Phone: (515) 395-3140
Email: Algona@bolton-menk.com
www.bolton-menk.com

DESIGNED	NO.	ISSUED FOR	DATE
TAC			
DRAWN			
JKF/ALH			
CHECKED			
TAC			
CLIENT PROJ. NO.	OP1-126016		

DRAINAGE DISTRICT NO. 57

CERRO GORDO COUNTY, IOWA

SEEDING AND FERTILIZING NOTES

SHEET

C.03

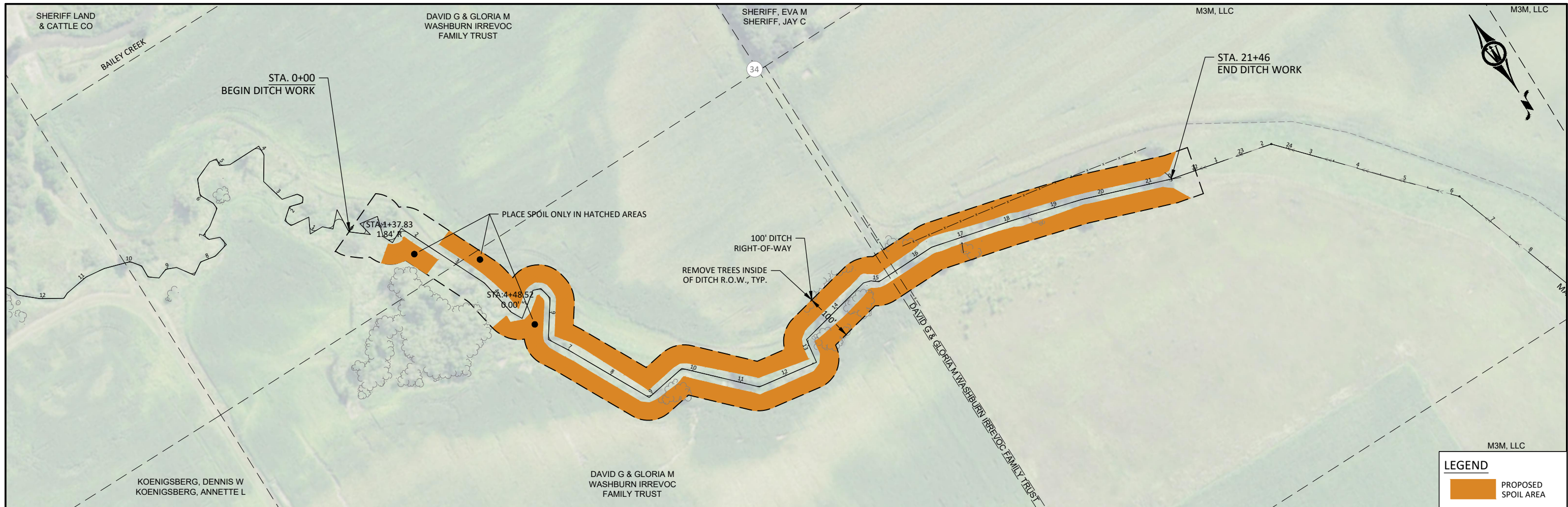

LEGEND

PROPOSED SPOIL AREA

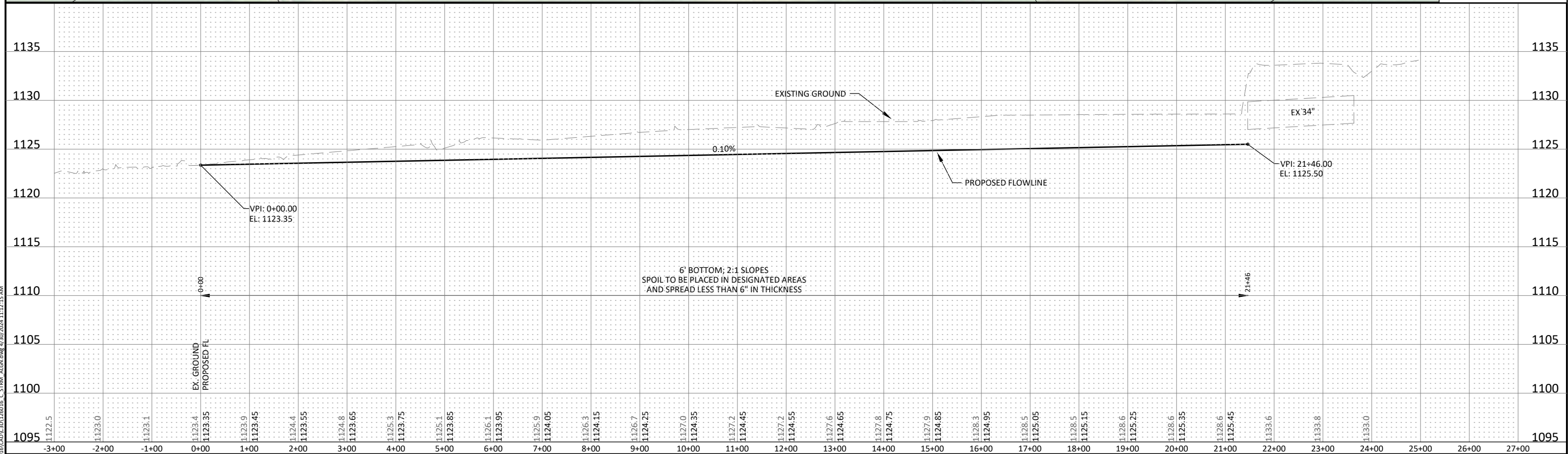

© Bolton & Menk, Inc. 2024. All Rights Reserved. ALGONA\DWG\126016\126016_C_STRM_ALGONA.dwg 4/30/2024 11:12:15 AM

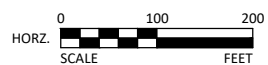

1609 US HWY 18 EAST
ALGONA, IOWA 50511
Phone: (515) 395-3140
Email: Algona@bolton-menk.com
www.bolton-menk.com

DESIGNED	NO.	ISSUED FOR	DATE
TAC			
DRAWN			
JKF/ALH			
CHECKED			
TAC			
CLIENT PROJ. NO.			
OP1.126016			

DRAINAGE DISTRICT NO. 57
CERRO GORDO COUNTY, IOWA
OPEN DITCH PLAN AND PROFILE

SHEET
D.01

© Bolton & Menk, Inc. 2024. All Rights Reserved.
ALGONONA\PI126016\CADD\126016_C_Corr_1.dwg 4/20/2024 11:12:24 AM

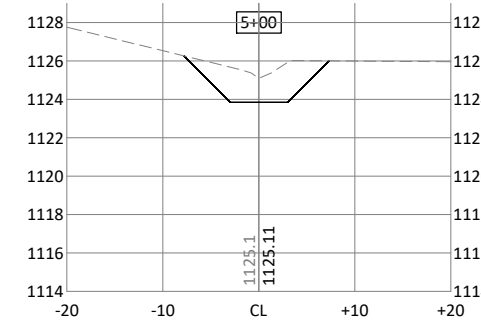
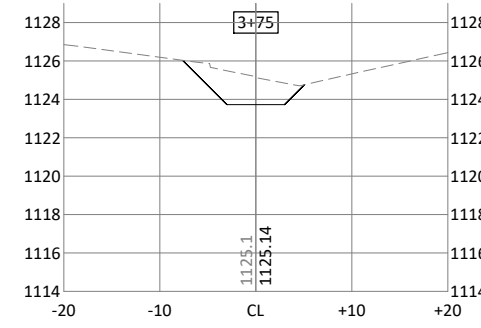
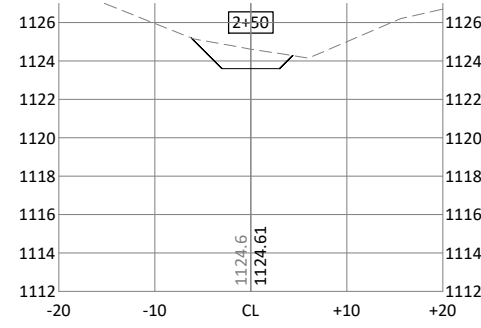
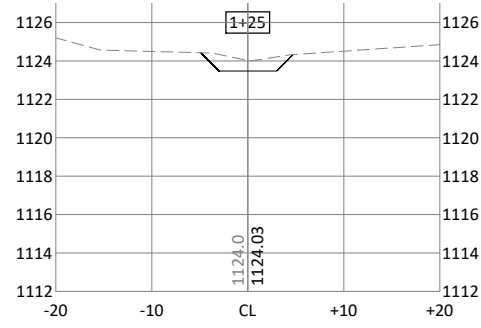
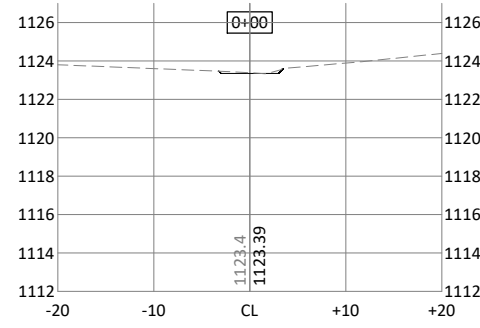
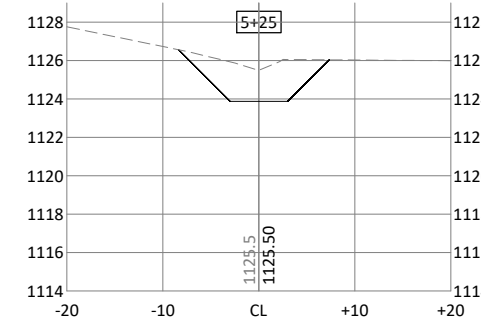
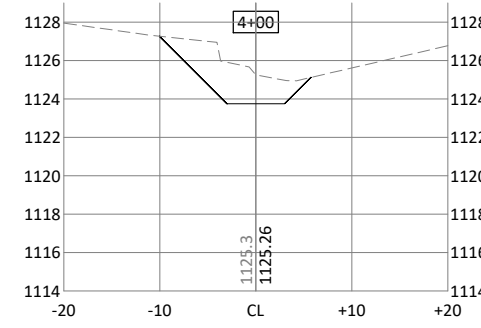
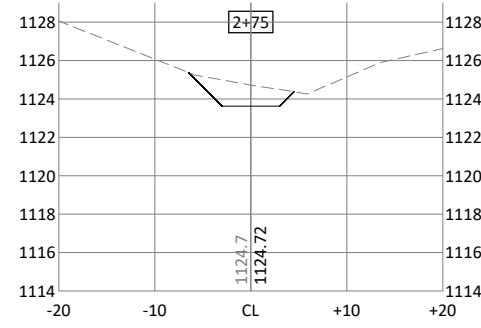
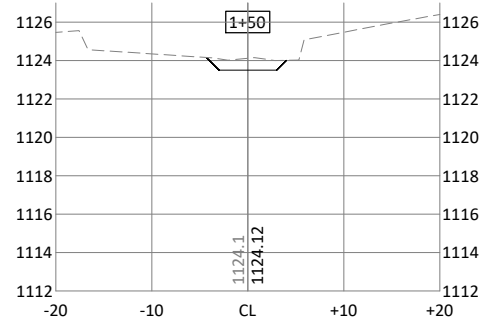
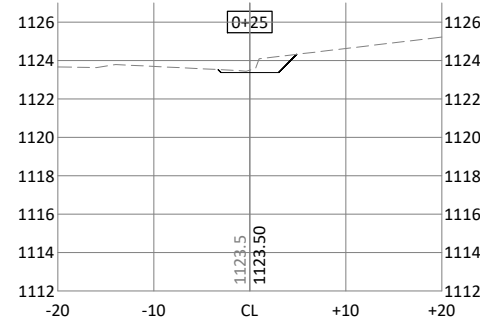
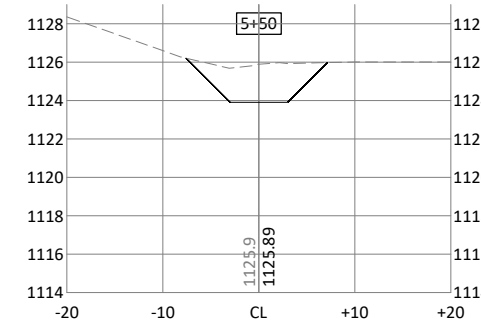
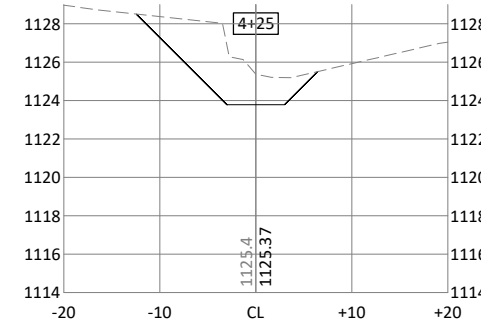
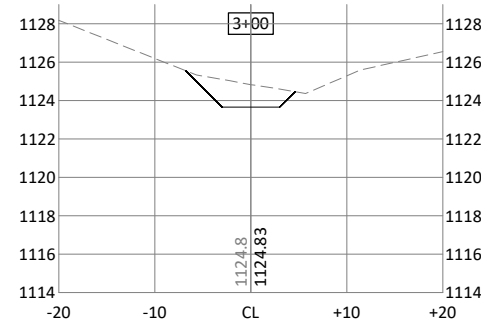
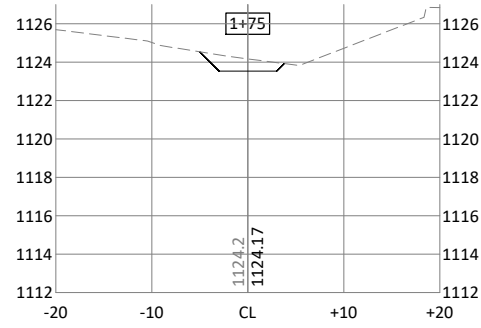
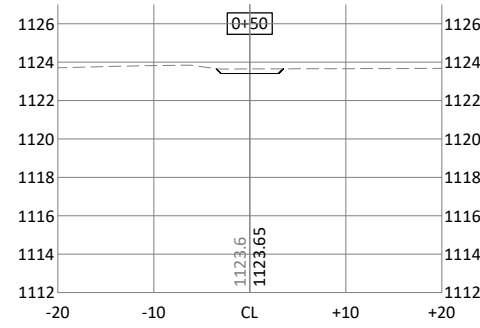
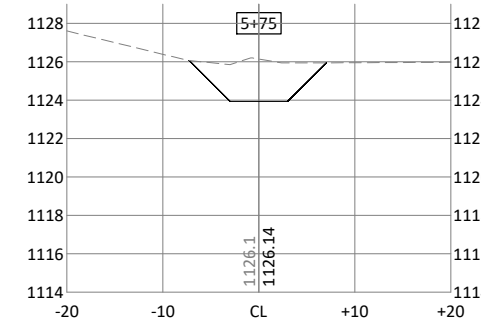
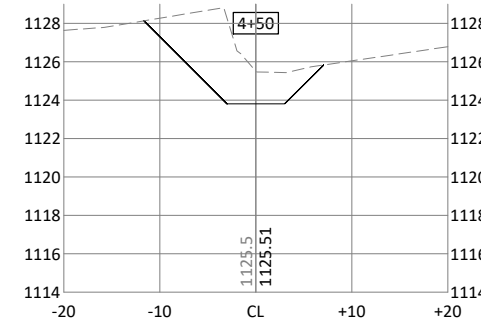
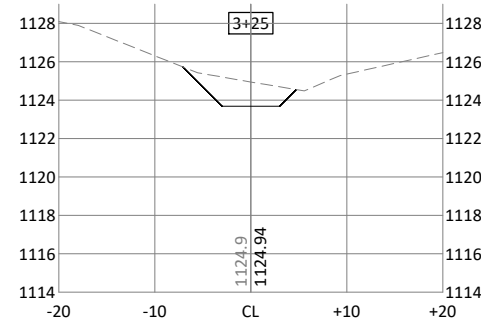
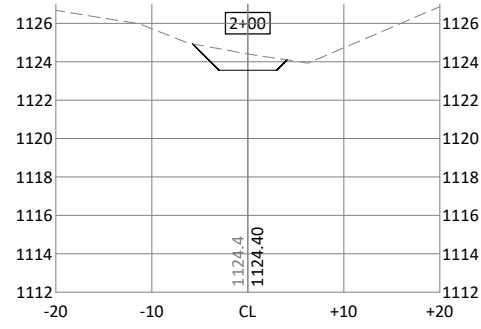
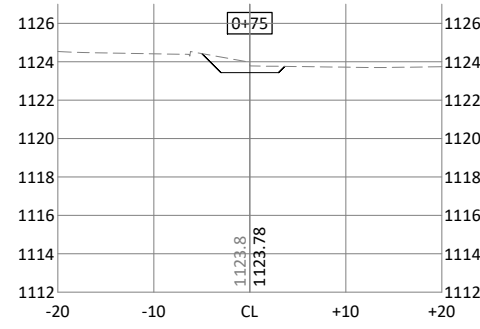
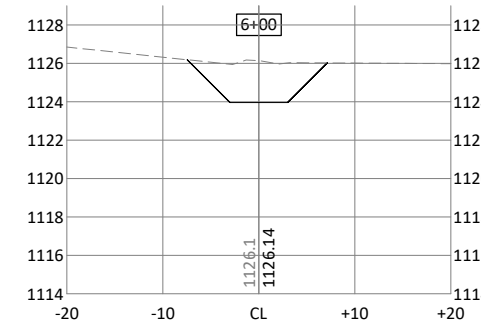
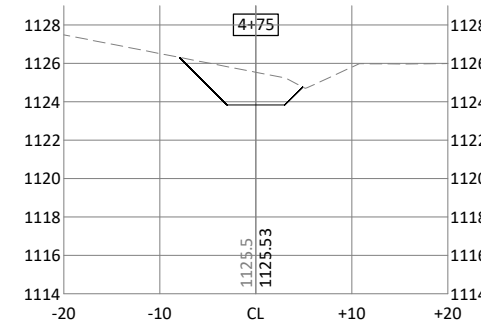
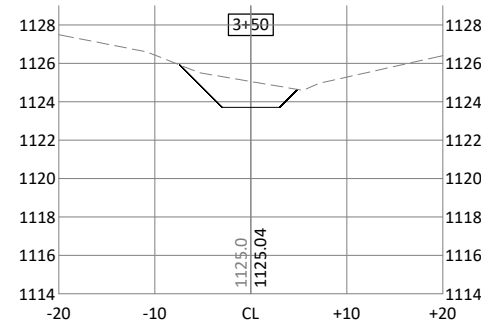
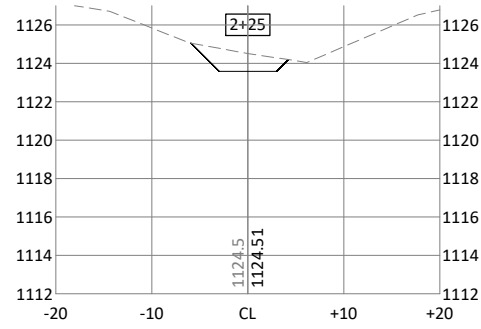
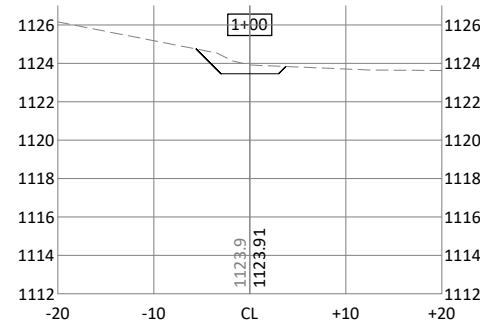

BOLTON & MENK

1609 US HWY 18 EAST
ALGONA, IOWA 50511
Phone: (515) 395-3140
Email: Algona@bolton-menk.com
www.bolton-menk.com

DESIGNED	NO.	ISSUED FOR	DATE
TAC			
DRAWN			
JKF/ALH			
CHECKED			
TAC			
CLIENT PROJ. NO.			
OP1126016			

DRAINAGE DISTRICT NO. 57
CERRO GORDO COUNTY, IOWA

CROSS SECTIONS

SHEET

X.01

© Bolton & Menk, Inc. 2024. All Rights Reserved.
ALGONONIA\PI126016\CAD\126016_C_CORR_1.dwg 4/20/2024 11:12:29 AM

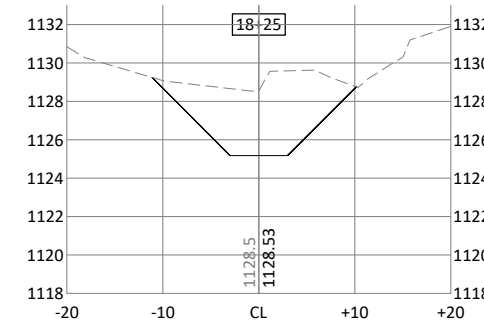
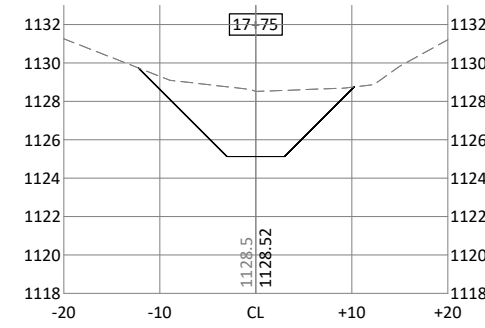
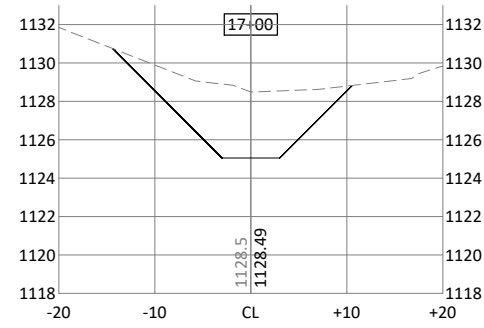
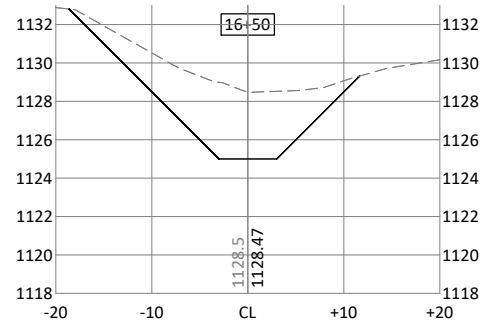
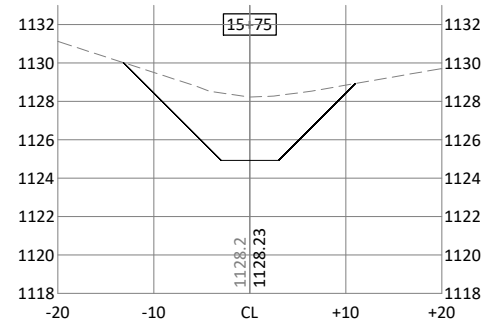
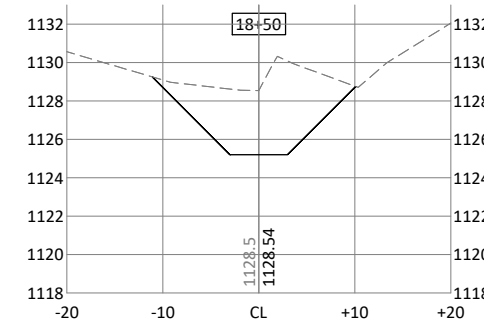
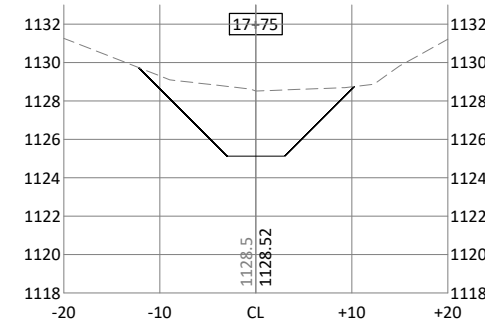
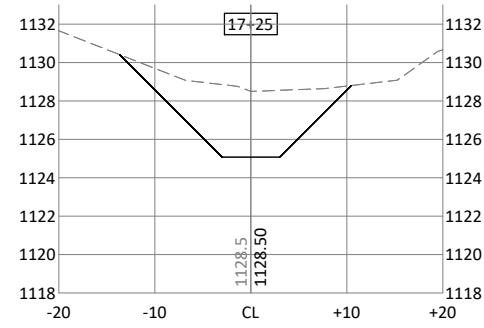
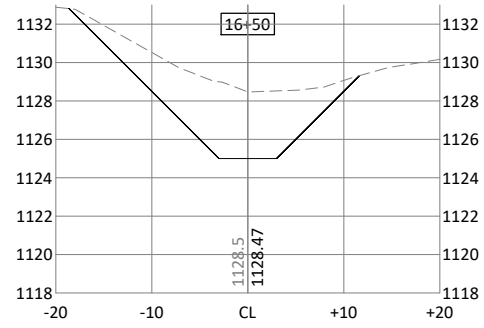
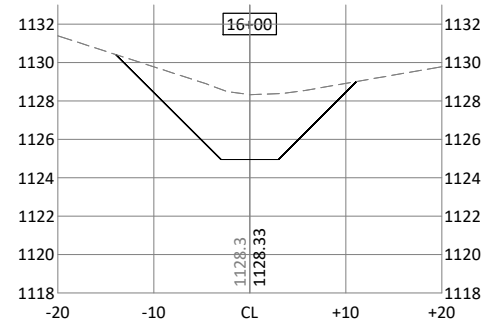
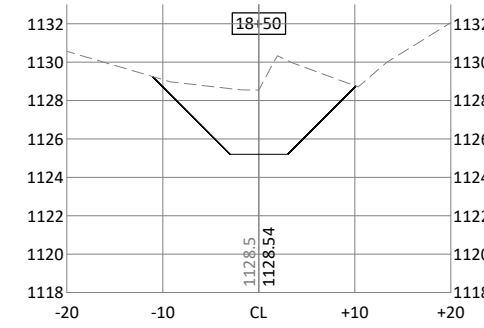
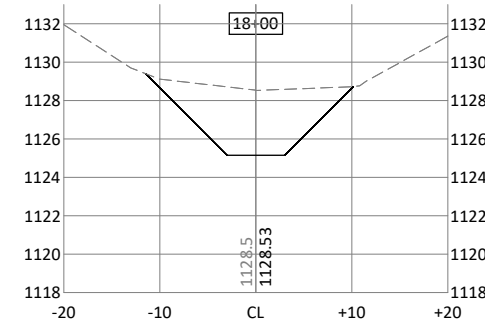
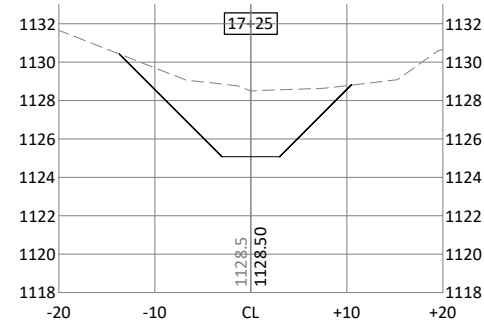
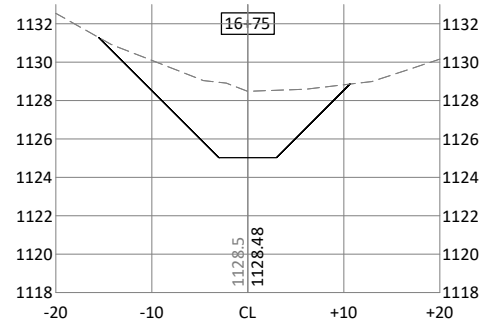
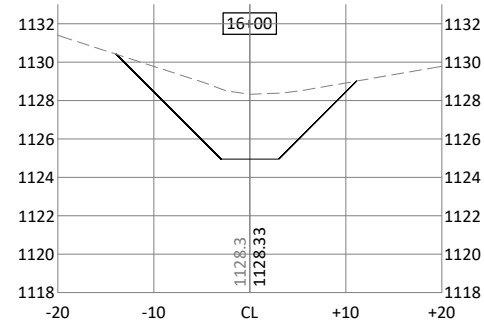
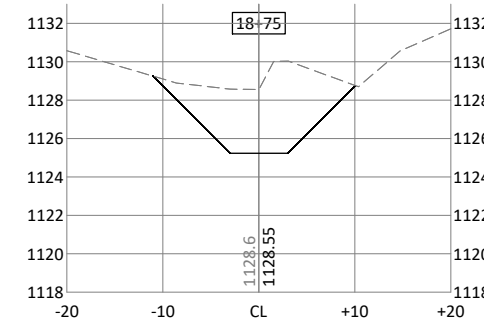
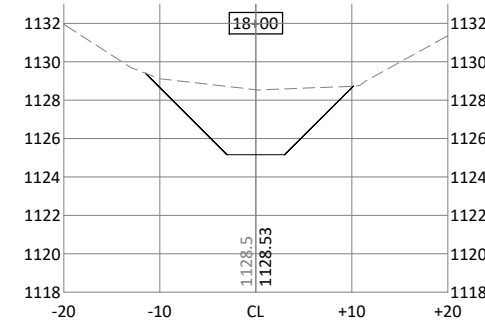
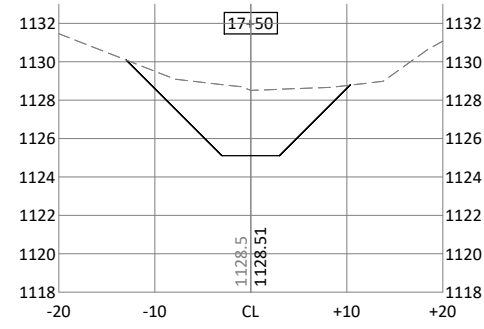
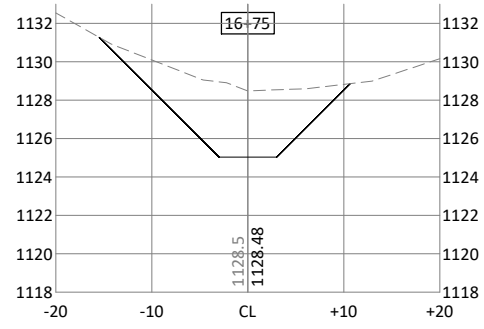
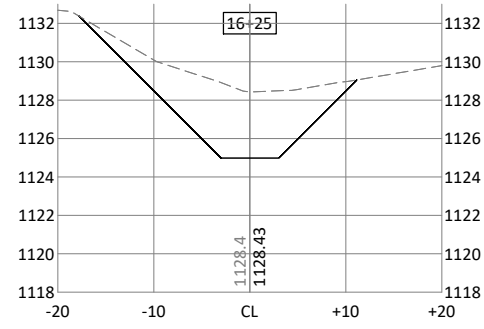
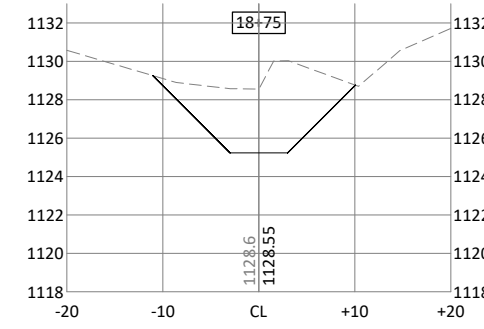
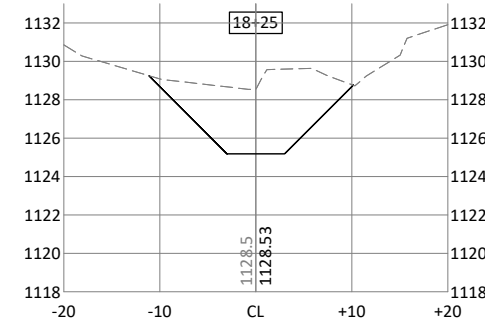
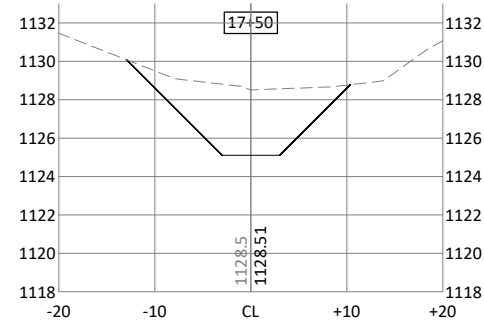
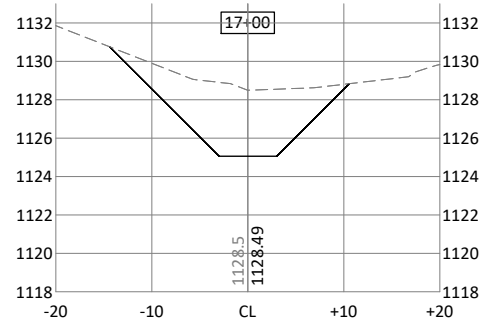
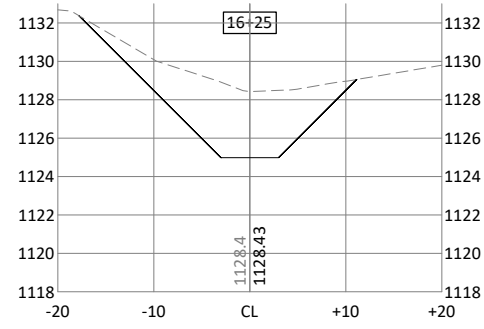

1609 US HWY 18 EAST
ALGONA, IOWA 50511
Phone: (515) 395-3140
Email: Algona@bolton-menk.com
www.bolton-menk.com

DESIGNED	NO.	ISSUED FOR	DATE
TAC			
DRAWN			
JKF/ALH			
CHECKED			
TAC			
CLIENT PROJ. NO.			
OP1.126016			

DRAINAGE DISTRICT NO. 57
CERRO GORDO COUNTY, IOWA
SECTION VIEW GROUP - 4 - (1)

SHEET
X.04

© Bolton & Menk, Inc. 2024. All Rights Reserved.
 ALGONOA\PI126016\CAD\126016_C_CORR_1.dwg 4/20/2024 11:12:30 AM

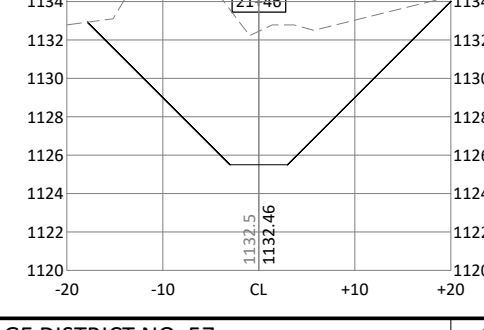
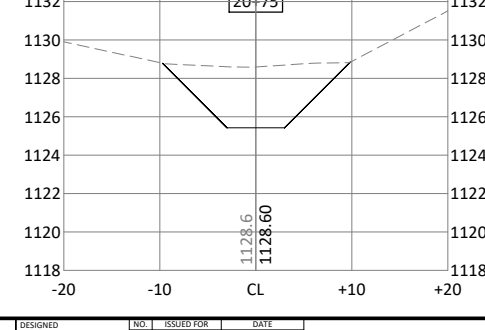
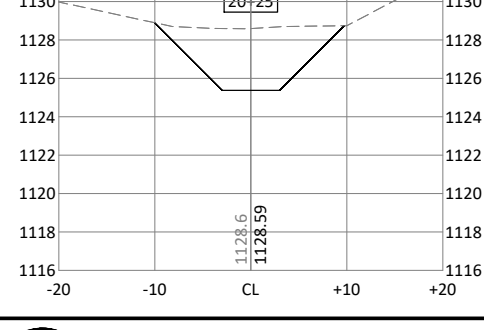
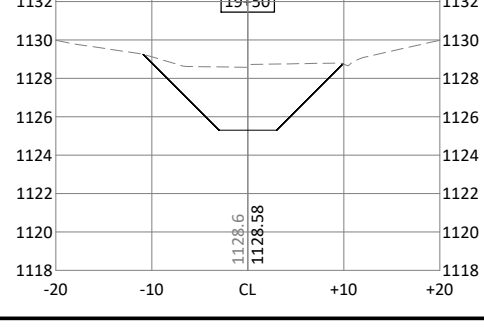
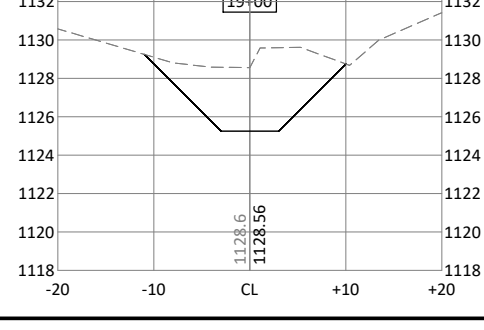
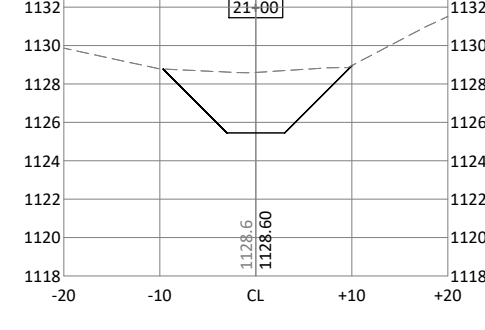
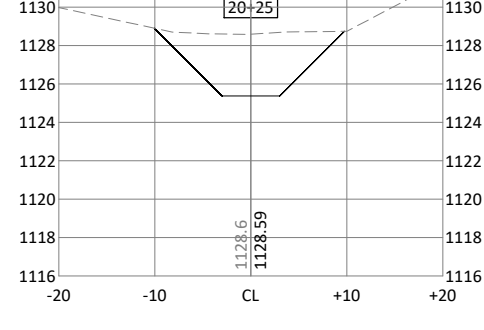
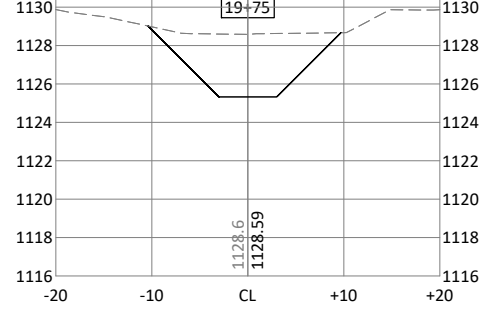
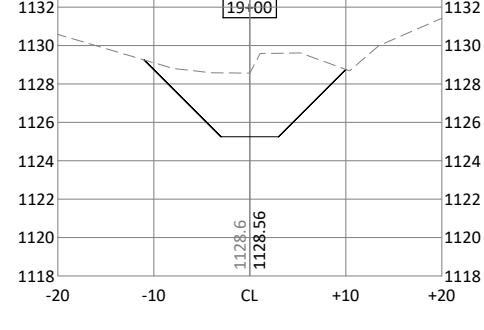
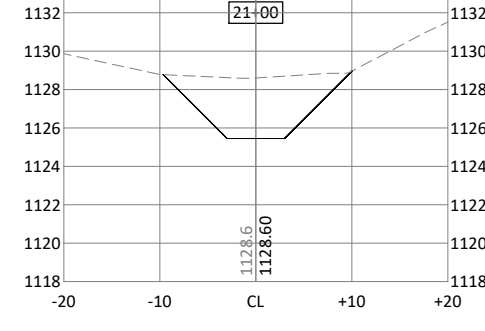
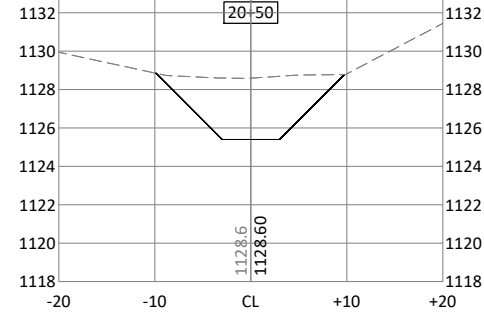
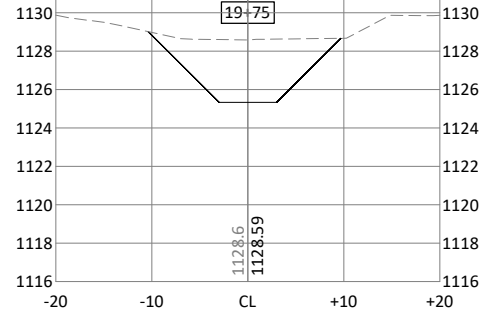
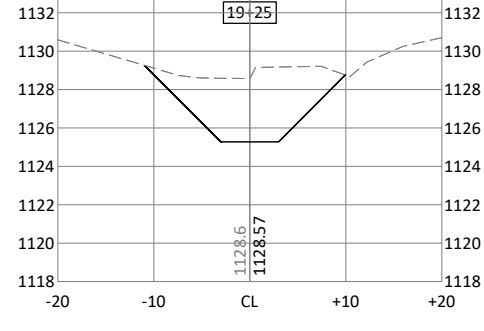
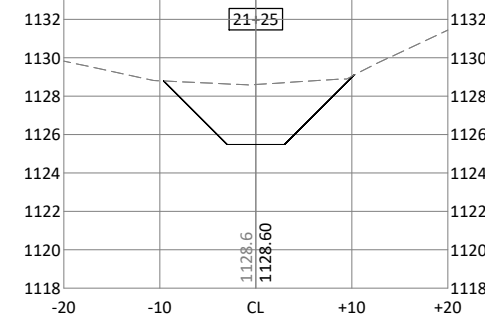
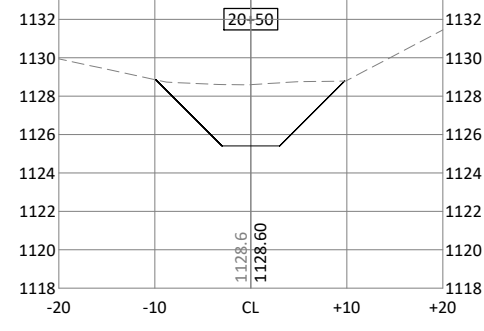
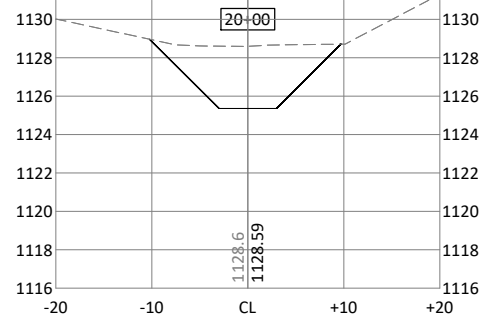
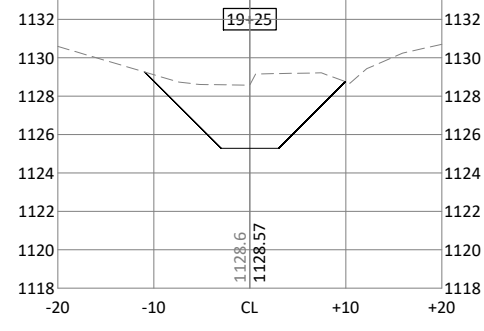
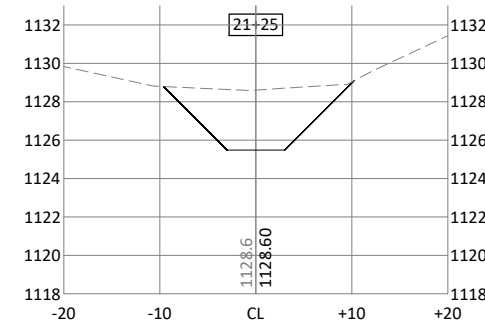
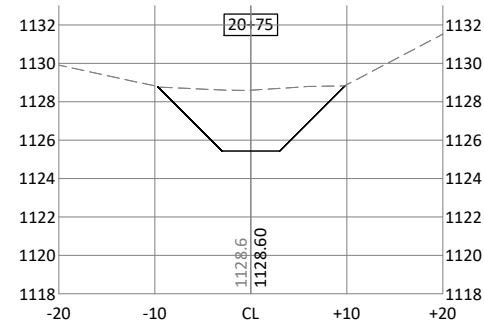
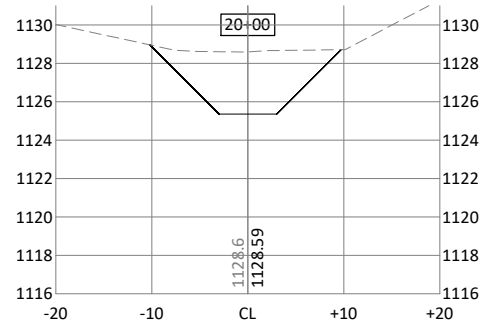
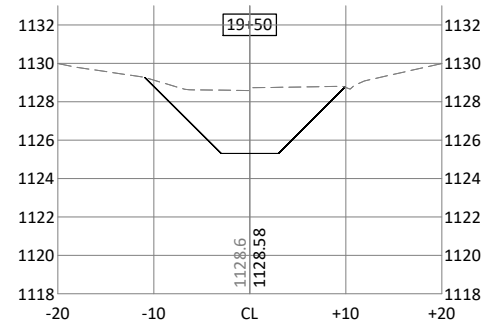

1609 US HWY 18 EAST
 ALGONA, IOWA 50511
 Phone: (515) 395-3140
 Email: Algona@bolton-menk.com
 www.bolton-menk.com

DESIGNED	NO.	ISSUED FOR	DATE
TAC			
DRAWN			
JKF/ALH			
CHECKED			
TAC			
CLIENT PROJ. NO.			
OP1.126016			

DRAINAGE DISTRICT NO. 57
 CERRO GORDO COUNTY, IOWA
 SECTION VIEW GROUP - 4 - (1)

SHEET
X.05